

**Design Manual For Structural
Stainless Steel - Commentary**
(Second Edition)

© 2003 Euro Inox and The Steel Construction Institute

Euro Inox and The Steel Construction Institute have made every effort to ensure that the information presented here is technically correct. However, the reader is advised that the material contained therein is for general information purposes only. Euro Inox, The Steel Construction Institute and any other contributor specifically disclaim any liability or responsibility for loss, damage or injury, resulting from the use of the information contained in this publication.

PREFACE

This Design Manual has been prepared by The Steel Construction Institute as a deliverable of the ECSC funded project, *Valorisation Project – Development of the use of stainless steel in construction* (contract 7215-PP-056). It is a complete revision of the *Design manual for structural stainless steel*, which was prepared by The Steel Construction Institute between 1989 and 1992 and published by Euro Inox in 1994.

This new edition takes into account advances in understanding in the structural behaviour of stainless steel over the last 10 years. In particular, it includes the new design recommendations from the recently completed ECSC funded project, *Development of the use of stainless steel in construction* (contract 7210-SA/842), which has led to the scope of the Design Manual being extended to cover circular hollow sections and fire resistant design. Over the last ten years a great many new European standards have been issued covering stainless steel material, fasteners, fabrication, erection, welding etc. The Design Manual has been updated to make reference to current standards and data in these standards.

A project steering committee, including representatives from each partner, sub-contractor and sponsoring organisation, oversaw the work and contributed to the development of the Design Manual.

The worked examples were completed by the following partners:

- Centre Technique Industriel de la Construction Métallique (CTICM)
- Luleå Institute of Technology
- RWTH Aachen
- Technical Research Centre of Finland (VTT)
- The Steel Construction Institute (SCI)

The following people were members of the steering committee and/or completed the design examples:

Nancy Baddoo	The Steel Construction Institute
Massimo Barteri	Centro Sviluppo Materiali (CSM)
Bassam Burgan	The Steel Construction Institute
Helena Burstrand Knutsson	The Swedish Institute of Steel Construction (SBI)
Lars Hamrebjörk	The Swedish Institute of Steel Construction (SBI)
Jouko Kouhi	Technical Research Centre of Finland (VTT)
Roland Martland	Health and Safety Executive (UK)
Enrique Mirambell	Universitat Politècnica de Catalunya (UPC)
Anders Olsson	AvestaPolarit AB (publ) (formerly, Luleå Institute of Technology)
Thomas Pauly	Euro Inox
Esther Real	Universitat Politècnica de Catalunya (UPC)
Ivor Ryan	Centre Technique Industriel de la Construction Métallique
Heiko Stangenberg	RWTH Aachen Institute of Steel Construction
Asko Talja	Technical Research Centre of Finland (VTT)

ACKNOWLEDGEMENTS

The following organisations provided financial support for this project:

- European Coal and Steel Community (ECSC)
- Euro Inox
- Health and Safety Executive (UK)

Their assistance is gratefully acknowledged.

FOREWORD

The *Design Manual for the Structural Design of Stainless Steel* has been prepared for the guidance of designers experienced in the design of carbon steel structural steelwork though not necessarily in stainless steel structures. It is not in any way intended to have a legal status or absolve the engineer of responsibility to ensure that a safe and functional structure results.

In 2002, the first two Parts of the Design Manual were published in seven languages (English, Finnish, French, German, Italian, Spanish and Italian):

- Part I Recommendations
- Part II Design Examples

The Design Examples contained in Part II demonstrate the use of the Recommendations. A cross-reference system locates that section of the examples corresponding to a particular recommendation.

The Recommendations and Design Examples are also available online via the Euro Inox web site (<http://www.euro-inox.org>).

This document forms Part III of the Design Manual; it is a Commentary to the Recommendations and includes a full set of references. It is available online via the Euro Inox web site and also via the Steelbiz web site (<http://www.steelbiz.org>). A CD is available from Euro Inox that contains all three Parts of the Design Manual in the various languages.

An online design facility is also available via the Euro Inox web site and at <http://www.steel-stainless.org/software> for designing cold formed stainless steel members subject to axial tension, bending or axial compression. The design facility calculates section properties and member resistances in accordance with the Recommendations in the Design Manual.

The purpose of the Commentary is to allow the designer to assess the basis of the Recommendations and to facilitate the development of revisions as and when new data become available. Opportunity has been taken to present the results of various test programmes conducted specifically to provide background data for the Design Manual. There is a one-to-one correspondence between the Sections in the Commentary and the Sections in the Design Manual, i.e. Section C.2.2 in the Commentary comments on Section 2.2 in the Recommendations.

The Recommendations in Part I are formulated in terms of limit state philosophy and, where appropriate, are in compliance with the following Parts of Eurocode 3 *Design of steel structures*, published as the following ‘pre-standards’ (ENV) Eurocodes between 1992 and 1997:

ENV 1993-1-1 *Design of steel structures: General rules and rules for buildings*

ENV 1993-1-2 *Design of steel structures: Structural fire design*

ENV 1993-1-3 *Design of steel structures: Cold formed thin gauge members and sheeting*

ENV 1993-1-4 *Design of steel structures: Stainless steels*

ENV 1993-1-5 *Design of steel structures: Plated structural elements*

(Note that ENV 1993-1-4 is very closely based on the First Edition of this Design Manual, with a few changes arising from the need to align to the provisions for carbon steel in ENV 1993-1-1 as much as possible.)

These Parts of Eurocode 3 contain recommended values for certain factors which are designated as 'boxed values'. These 'boxed values' are subject to modification at a national level, and the modified values given in a National Application Document to each Part.

The Parts are currently (December 2002) being converted to full EN European Standards, and their contents have been re-organised into a greater number of separate Parts; those relevant to this Design Manual are listed below:

EN 1993-1-1 *Design of steel structures: General rules and rules for buildings*

EN 1993-1-2 *Design of steel structures: Structural fire design*

EN 1993-1-3 *Design of steel structures: Cold formed thin gauge members and sheeting*

EN 1993-1-4 *Design of steel structures: Stainless steels*

EN 1993-1-5 *Design of steel structures: Plated structural elements*

EN 1993-1-8 *Design of steel structures: Design of joints*

EN 1993-1-9 *Design of steel structures: Fatigue strength of steel structures*

EN 1993-1-10 *Design of steel structures: Selection of materials for fracture toughness and through thickness properties*

It is expected that EN 1993-1-1, 1-2, 1-8, 1-9 and 1-10 will be published in 2003, with the other Parts following on afterwards. During the conversion process, boxed values that were given in the ENV stage are in general being replaced by Nationally Determined Parameters. These parameters will be defined at a national level and given in a National Annex to each Part. The National Annex will be prepared once the relevant Part of EN 1993 is finalised.

This Design Manual gives recommended values for certain factors. These values may be subject to modification at a national level.

The design recommendations presented in this Design Manual are based upon the best knowledge available at the time of publication. However, no responsibility of any kind for injury, death, loss, damage or delay, however caused, resulting from the use of the recommendations can be accepted by the project partners or others associated with its preparation.

Contents

	Page No.
PREFACE	iii
ACKNOWLEDGEMENTS	iv
FOREWORD	v
C.1 INTRODUCTION	9
C.1.1 Scope	9
C.1.2 Symbols and conventions for member axes	9
C.2 BASIS OF DESIGN	10
C.2.1 General requirements	10
C.2.2 Limit state design	10
C.2.3 Loading	11
C.3 MATERIALS: PROPERTIES AND SELECTION	12
C.3.1 Material grades	12
C.3.2 Mechanical behaviour and design values of properties	14
C.3.3 Physical properties	23
C.3.4 Effects of temperature	23
C.3.5 Selection of materials	23
C.3.6 Durability	26
C.4 PROPERTIES OF SECTIONS	30
C.4.1 General	30
C.4.2 Maximum width-to-thickness ratios	30
C.4.3 Classification of cross-sections	30
C.4.4 Effective widths	32
C.4.5 Stiffened elements	36
C.4.6 Calculation of section properties	37
C.4.7 Resistance of cross-sections	40
C.5 MEMBER DESIGN	42
C.5.1 Introduction	42
C.5.2 Tension members	44
C.5.3 Compression members	45
C.5.4 Flexural members	53
C.5.5 Members subject to combinations of axial loads and bending moments	60
C.6 JOINT DESIGN	61
C.6.1 General recommendations	61
C.6.2 Bolted connections	61
C.6.3 Welded connections	75
C.7 FIRE RESISTANT DESIGN	77
C.7.1 General	77
C.7.2 Mechanical properties at elevated temperatures	77
C.7.3 Thermal properties at elevated temperatures	78
C.7.4 Determination of structural fire resistance	78

C.8	FATIGUE	81
C.8.1	Introduction	81
C.8.2	S-N data for stainless steels	81
C.8.3	Fatigue crack growth data for stainless steels	83
C.9	TESTING	89
C.10	FABRICATION ASPECTS	90
C.10.1	Introduction	90
C.10.2	Storage and handling	90
C.10.3	Shaping operations	90
C.10.4	Welding	90
C.10.5	Galling and seizure	91
C.10.6	Finishing	91
APPENDIX A	Correlation between stainless steel designations	92
APPENDIX B	Lateral-torsional buckling slenderness, λ_{LT}	93
APPENDIX C	Material data for deflection calculations	94
REFERENCES		95

C.1 INTRODUCTION

C.1.1 Scope

There are many different types and grades of stainless steel (see Section C.3.1.1). These have been formulated over the last 80 years or so to optimise certain characteristics such as corrosion resistance in specific environments, weldability and mechanical properties. The Recommendations in this Design Manual are applicable to the grades of stainless steel commonly used in construction, as given in Table 3.1.

The Design Manual concentrates on the design of members and elements, not on the behaviour and design of frameworks. Thus no recommendations are given for elastic or plastic global analysis (except that elastic global analysis should be used) and reference should be made to carbon steel codes as necessary. In particular, the designer will need to consider second order effects in stainless steel sway frames. These could be potentially greater than in carbon steel frames if the steel is stressed into the non-linear portion of the stress-strain curve.

No limits to thickness are given; the normal limitations for carbon steel do not apply due to the superior performance of stainless steel materials. However, there will be practical limits for the cold forming of members (approximately 20 mm for the austenitic grades and 15 mm for duplex grade 1.4462).

Pressure vessels, pipework and structures within nuclear installations are not covered. Other codes, such as the ASME pressure vessel code¹, may be consulted.

C.1.2 Symbols and conventions for member axes

As stated, the notation of ENV 1993-1-1² has been generally adopted, in which extensive use is made of subscripts. It is not necessary to use the subscripts if clarity is not impaired.

Attention is drawn to the use of the x axis as being along the length of the member, and the major axis of bending as being about y-y.

C.2 BASIS OF DESIGN

C.2.1 General requirements

The aims in designing a stainless steel structure are no different from those in carbon steel structures. That is a safe, serviceable and durable structure should result. As well as the more obvious considerations such as strength and stability, the design of a structure should take account of the following:

- Safe transport and handling.
- Safe means of interconnection.
- Stability during erection.

One designer should be responsible for ensuring the overall stability of the structure, particularly if stainless steel is used in conjunction with other materials. In the design of the stainless steel structure, the assumed restraint and stability afforded by other materials should be clearly stated and made known to the engineer responsible.

C.2.2 Limit state design

In limit state design, the performance or capacity of the structure or its components is assessed against various criteria (the limit states) at appropriate load levels. For carbon steel structures, the designer is mainly concerned with the ultimate limit states, which potentially could lead to loss of life, and serviceability limit states, which could lead to loss of function. The reduction in structural performance of carbon steel building structures due to corrosion is not usually specifically considered by the structural designer, reliance instead being placed upon paint or other protective coatings. Where corrosion is likely to affect performance, as for marine or offshore structures, the use of a sacrificial corrosion allowance on the thickness or of cathodic protection is common. However, for stainless steel, anti-corrosion measures should form an integral part of the design, from material selection to detailing of member and joints, and must be carried through fabrication and erection. Thus, in Section 2.2 of the Recommendations, the durability limit state is on an equal footing to the ultimate and serviceability limit states.

In Section 2.2, creep is given as an example of a serviceability limit state. Stainless steel can exhibit noticeable creep-like deformations at room temperature if stresses exceed approximately two thirds of the 0,2% proof strength. It is arguable as to whether creep should be considered as an ultimate limit state or as a serviceability limit state. For pressure vessels, creep rupture is clearly an ultimate limit state. In other structures, the situation is not as clear. For instance, in a column any additional creep deformation will influence the load carrying capacity of that column and hence creep should perhaps be considered at the ultimate limit state. However, for beams, creep deformations are manifested by increased beam deflections that may exceed permissible levels; in this instance creep has to be considered at the serviceability limit state. In this Design Manual, the view has been taken that the ultimate limit state can be exceeded by a short-term overload condition, and that creep deformations would be manifested before the overload condition occurs. Thus, if creep were considered at the serviceability limit state it would not be significant at the ultimate limit state for the load factors used in this Design Manual.

The values of the partial safety factor for resistance, γ_M , given in Table 2.1 are taken from ENV 1993-1-4, which states that the values for γ_M given in ENV 1993-1-1 for carbon steel are applicable to stainless steel. Note that certain European countries specify modified γ_M values in their National Application Documents, and, where this is the case, these values must be used in the place of the values given in ENV 1993-1-4. Table C.2.1 lists the γ_M values given in the National Application Documents of seven European countries. These values are applicable until EN 1993-1-4 and its accompanying National Annexes (which contain values for partial safety factors) are published.

Table C.2.1 *Partial safety factors for different European countries*

Partial safety factor	Finland	France	Germany	Italy	Spain	Sweden	UK
γ_{M0}	1,1	1,1 ¹⁾	1,1	1,05	1,1	1,0	1,05
γ_{M1}	1,1	1,1	1,1	1,05	1,1	1,0	1,05
γ_{M2}	1,25	1,25	1,25	1,2	1,25	1,2	1,2

Note:

1) $\gamma_{M0} = 1,0$ for steel products marked NF.

C.2.3 Loading

It is the responsibility of the designer to consider all load effects (dead loads, imposed loads, effects of temperature and settlement, etc.) and establish the most onerous load case for each member.

As for the γ_M factors, different values of γ_F may be set in the National Application Document for the country for which the structure is being designed.

For offshore applications, the partial safety factor for loads for the in-place condition are taken from API RP2A³. API RP2A also recommends factors for transportation, earthquake loadings, etc. and should therefore be consulted. Generally, the offshore factors are higher than those onshore. This is generally intended to achieve a higher level of reliability.

C.3 MATERIALS: PROPERTIES AND SELECTION

C.3.1 Material grades

C.3.1.1 Introduction

Stainless steels can be classified into five groups, according to their chemical composition (see Figure C.3.1) and thermomechanical treatment. Each group has different properties, particularly in respect of strength, corrosion resistance and ease of fabrication.

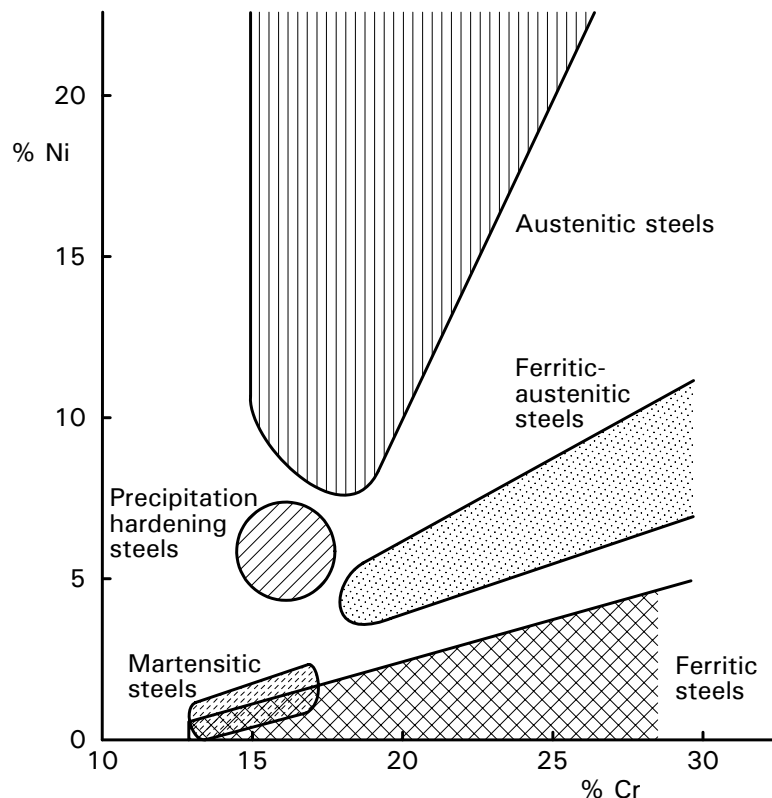

Figure C.3.1 *Classification of stainless steels according to nickel and chromium content*

The five groups can be summarised thus:

Austenitic stainless steels

These are the most commonly used stainless steels. They have an austenitic microstructure at room temperature and generally contain relatively high amounts of nickel. They have high ductility, are easily formed, are readily weldable and offer good corrosion resistance. Their strengths are reasonable and they can only be hardened (i.e. made stronger) by cold working.

Ferritic stainless steels

The ferritic stainless steels contain relatively little nickel and have a ferritic microstructure. Ductility, strength, formability and weldability are not as good as in the austenitic steels. Although they are generally not as corrosion resistant as the austenitic grades, they are superior when considering stress corrosion cracking. As for the austenitic grades, they can only be hardened by cold working.

Martensitic stainless steels

These steels can be hardened by heat treatment and are not normally used in welded fabrication. Great strengths can be achieved with these steels but in other respects they are poorer than the other groups.

Duplex stainless steels

These steels have a mixed microstructure and combine the best of the properties of the austenitic and ferritic groups. Compared to the austenitic group they have higher mechanical strengths, similar weldability, lower formability and similar or higher corrosion resistance especially with respect to stress corrosion cracking. They are hardened by cold working.

Precipitation hardening steels

These offer the highest strengths, obtained by suitable heat treatments. They are not normally used in welded fabrications.

Further information on the various groups and types of stainless steels may be found in standard texts such as the ASM Handbook⁴.

Most structural applications use austenitic grades 1.4301, 1.4401 or their low carbon variants 1.4307 and 1.4404. A wide range of product forms is available in these grades. (Note that in Germany, the low carbon version of 1.4301 widely used is grade 1.4306, a slightly higher alloyed version of 1.4307.) The duplex grade 1.4462 is also widely available and experience of this grade has been gathered in the offshore industry. Duplex grades offers advantages in mechanical strength and corrosion resistance, especially where stress corrosion cracking may be a problem.

If there is any doubt as to which of these grades, or indeed any other grade, is suitable for a particular application, specialist advice should be sought. Stainless steel producers commonly give such advice, often free of charge.

The Recommendations are only intended for the wrought forms of the selected alloys. Cast forms generally have equivalent corrosion resistance to that of the wrought forms but several differences exist. One of the more important of these is that the microstructure of cast austenitic stainless steels contains a greater amount of ferrite. This not only facilitates weld repair of castings but also increases the resistance to stress corrosion cracking. Cast steels also differ in mechanical properties, physical properties and chemical composition. Because of the formation of larger grain sizes and other differences in microstructure, mechanical properties of cast steels exhibit a wider range and are generally inferior to wrought steels.

C.3.1.2 Relevant standards

The European material standard for stainless steel is EN 10088, *Stainless Steels*⁵ and this covers flat products and long products. Fasteners are covered in EN ISO 3506, *Corrosion-resistant stainless steel fasteners*⁶.

When specifying for ordering purposes it is important to provide a complete specification that should include:

- The desired quantity.
- The type of manufacture (hot rolled or cold rolled) and the product form (strip or sheet/plate).
- Where an appropriate dimensional standard is available, the number of the standard, plus any choice of requirements.
- If there is no dimensional standard, the nominal dimensions and tolerances required.
- The type of material (steel) and its steel number or name with the relevant European standard (EN 10088).
- If, for the relevant steel, more than one treatment condition is covered, the symbol for the desired heat treatment or cold worked condition.
- The desired process route and surface finish.
- If an inspection document is required, its designation according to EN 10204⁷.

The recommendation that samples of fasteners should be tested follows from an understrength batch of setscrews discovered in tests⁸.

C.3.2 Mechanical behaviour and design values of properties

C.3.2.1 Basic stress-strain behaviour

As well as non-linearity, the stress-strain characteristics of stainless steels also display non-symmetry of tensile and compressive behaviour and anisotropy (differences in behaviour of coupons aligned parallel and transverse to the rolling direction). In the annealed (softened) condition, the stress-strain curves tend to be more non-linear in tension than in compression. Tests on both cold and hot rolled material indicate higher strengths transverse to the rolling direction than in the direction of rolling⁹. Unidirectional work hardening results in a reduced proof stress in the direction opposite to the work hardening direction. As for other types of steel, even for small levels of work hardening, this reduction can be such that the proof stress in compression of a plate work hardened by stretching is below its original value before work hardening¹⁰.

The degree of non-linearity, non-symmetry and anisotropy varies between grades of stainless steel. For an annealed material, the differences due to non-symmetry and anisotropy are not large but nevertheless they have been taken into account in Appendix C. Except for thin sheets (less than, say, 4 mm for which work hardening imparted during rolling may have an impact), there does not appear to be a significant thickness effect on the relationship between the four basic stress-strain curves^{11,12}.

In discussing the form of the stress-strain curve, it is helpful to consider the Ramberg-Osgood idealised form¹³ given by:

$$\varepsilon = \frac{\sigma}{E} + 0,002 \left(\frac{\sigma}{\sigma_{0,2}} \right)^n$$

Inspection of this equation shows that there are three independent parameters required to define a particular stress-strain curve, i.e.

E is Young's modulus

$\sigma_{0,2}$ is the 0,2% proof strength

n is an index

The degree of non-linearity of the stress-strain curve is characterised by the index n ; lower n values imply a greater degree of non-linearity, see Figure C.3.2.

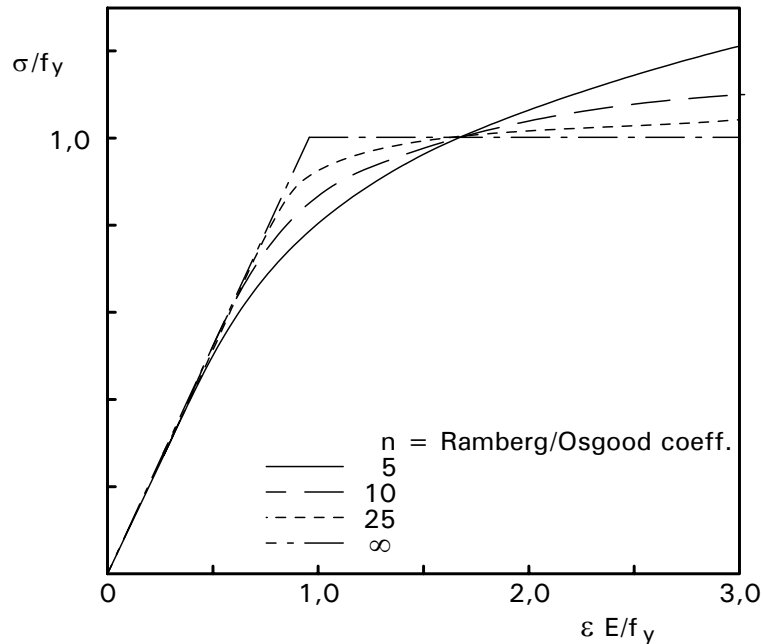

Figure C.3.2 *Effect of the parameter n on the non-linearity of the stress-strain curve*

The value of n may be obtained from the ratio of the stress at the limit of proportionality (conventionally the 0,01% proof strength, $\sigma_{0,01}$) to the 0,2% proof strength, $\sigma_{0,2}$, as follows:

$$n = \frac{\log(0,05)}{\log(\sigma_{0,01} / \sigma_{0,2})}$$

and thus the ratio $\sigma_{0,01}/\sigma_{0,2}$ may also be used as an indicator of the degree of non-linearity.

Table C.3.1 shows the averaged stress-strain characteristics obtained from the test programme specifically carried out for the First Edition of this Design Manual¹².

Table C.3.1 *Representative values of stress-strain characteristics for materials in the annealed condition*

Material	Direction & Sense of Stress	0,2% Proof strength (N/mm ²)	Modulus of elasticity (kN/mm ²)	$\frac{\sigma_{0,01}}{\sigma_{0,2}}$	Index <i>n</i>
1.4307	LT	262	194	0,65	7,1
	LC	250		0,62	6,3
	TT	259	198	0,71	8,8
	TC	255		0,72	9,0
1.4404	LT	277	193	0,65	6,9
	LC	285		0,71	8,6
	TT	286	198	0,70	8,5
	TC	297		0,74	10,0
1.4462	LT	518	199	0,57	5,4
	LC	525		0,56	5,2
	TT	544	207	0,54	4,8
	TC	540		0,59	5,7
LT	-	Longitudinal tension			
LC	-	Longitudinal compression			
TT	-	Transverse tension			
TC	-	Transverse compression			

Note these values should be considered as representative and not as typical or characteristic values. Other data sources were also examined to select the design values in Appendix C¹².

From a structural point of view, the results in Table C.3.1 suggest that anisotropy and non-symmetry of annealed materials are not as important as the non-linearity.

The rounded stress-strain curve affects the strength and stiffness of a member, depending on the stress level in the member. In a compression member for instance, buckling failure is related to the associated value of the tangent modulus; thus, for failure stresses below the proof strength, it can be expected that a stainless steel column will tend to be weaker than a similar carbon steel column of the same proof strength. On the other hand, for failure stresses above the proof strength, a stainless steel column will be stronger than the corresponding carbon steel one. Further explanation is given in Section C.5.3.1.

Although the Ramberg-Osgood formulation gives excellent agreement with experimental stress-strain data up to the 0,2% proof strength, at higher strains, the model generally over estimates the stress corresponding to a given level of strain. Mirambell and Real¹⁴ recently proposed the use of two adjoining Ramberg-Osgood curves to achieve improved modelling accuracy at strains above the 0,2% proof strength. The basic Ramberg-Osgood expression is used up to the 0,2% proof stress, then a modified expression re-defines the origin for the second curve as the point of 0,2% proof stress, and ensures continuity of gradients. Figure C.3.3 demonstrates the improved accuracy at higher strains of this compound Ramberg-Osgood expression. Gardner¹⁵ has proposed a modification to Mirambell and Real's model to describe compressive stress-strain behaviour.

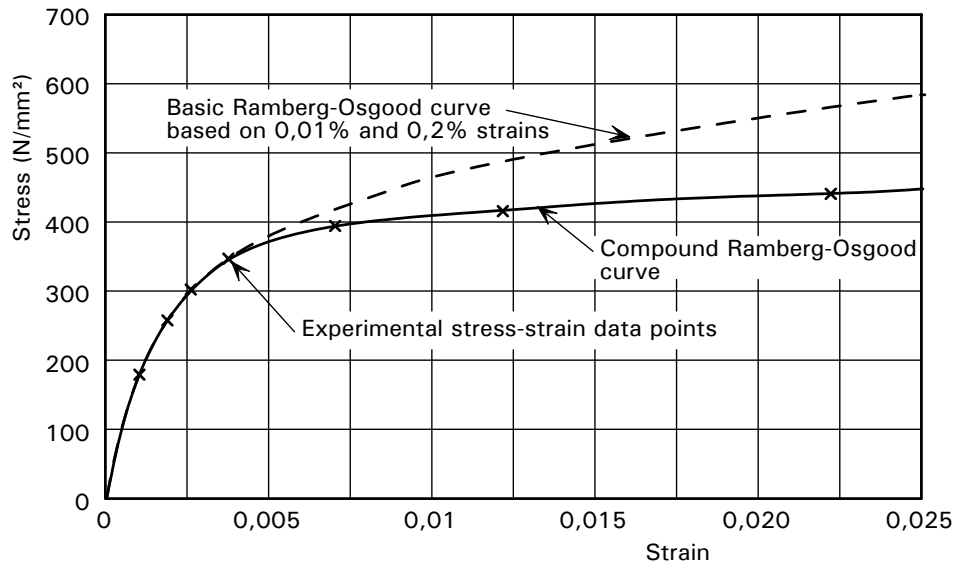

Figure C.3.3 Comparison between compound and basic Ramberg-Osgood models

C.3.2.2 Factors affecting stress-strain behaviour

Cold working

Stainless steels are generally supplied in the annealed (softened) condition and the mechanical properties given in EN 10088 relate to material in this condition. However, austenitic stainless steels (and to a lesser extent duplex steels) develop high mechanical strengths when cold worked. In part this is due to a partial transformation of austenite to martensite. The degree of strength enhancement is affected by chemical composition^{11,16}. Austenite stabilising elements, such as nickel, manganese, carbon and nitrogen tend to lower the rate of strength enhancement.

Figure C.3.4, taken from Reference 11, shows the effect of cold work on the 0,2% proof strength, the ultimate tensile strength and elongation at failure for a specific sample of 1.4307. Similar relationships apply to grade 1.4404. The corresponding curves for duplex 1.4462 are shown in Figure C.3.5 obtained from manufacturer's literature.

In general anisotropy and non-symmetry increase with cold work. It is important to remember that welding or certain heat treatments will anneal, or partially anneal, the cold worked material, with a consequent loss of the enhanced strength¹⁷. Deflections may frequently govern the design of cold rolled stainless steel rather than strength.

Cold working can occur at two stages in the production of a structural component - during production of the flat product and/or during fabrication of the finished structural component.

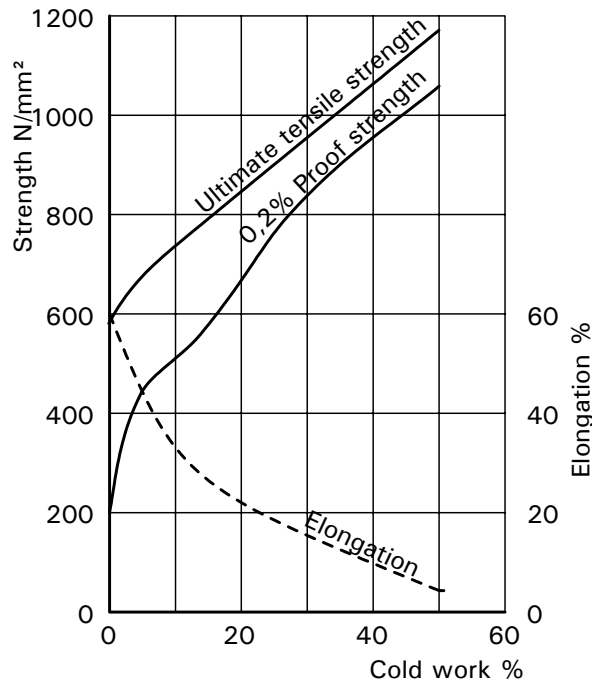

Figure C.3.4 Effect of cold working on a sample of 1.4307 material

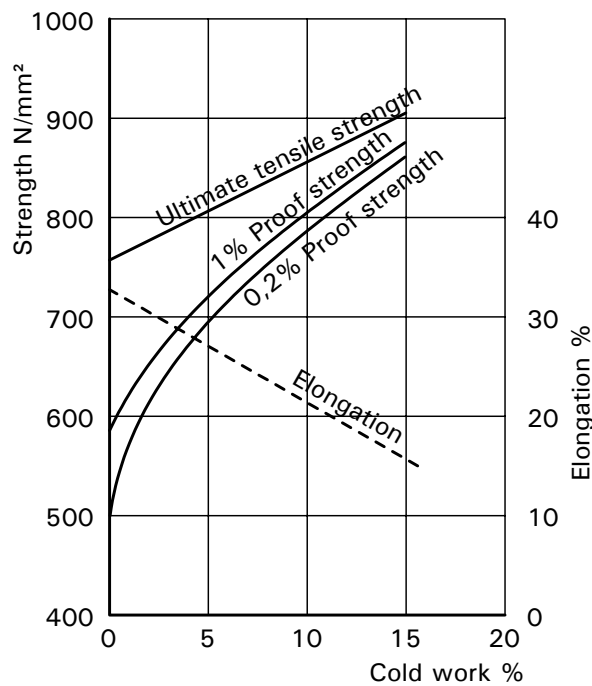

Figure C.3.5 Effect of cold working on a sample of duplex 1.4462 material

Cold working during production of the flat product

Stainless steel can be cold worked during production of the strip by a temper rolling or stretching process; the former process is more common. EN 10088 gives five tensile strength levels for material in the cold worked condition, with ultimate tensile strengths from 700 N/mm² to in excess of 1300 N/mm². The design provisions in ENV 1993-1-4¹⁸ are applicable to material with a design strength of up to 480 N/mm². However, the provisions were not validated against experimental data from cold worked material. Experience with carbon steel suggests that the design provisions are likely to be very conservative for cold worked material, particularly the limiting width-to-thickness ratios for section classification and the expressions for axial resistance.

Talja¹⁹ has recently tested rectangular hollow sections, top hat sections and trapezoidal sheeting profiles using strip in the cold worked condition. This is part of an ECSC-funded project (contract 7210-PR-318) to develop economic guidance on the structural design of cold worked austenitic stainless steel (due for completion in 2004).

Note that in America, it is possible to purchase sheet and plate materials in various cold worked conditions or tempers, e.g. ¼ hard, ½ hard, fully hardened, etc.

The use of cold worked material for structural applications has great potential that has not yet been exploited. Cold worked stainless steel is currently manufactured by the major European producers; however, at present, the only structural sections made from the material are rectangular hollow sections.

Cold working during fabrication of the finished structural component

This is generally known as cold forming, and typically occurs at the corners of sections where the 0,2% proof strength can rise between 20% and 100% higher than the 0,2% proof strength of the flat regions. Work has been carried out to develop an expression to predict the corner mechanical properties of cold formed stainless steel material^{15,20}. The increased strength is, however, localised at the position of bending (e.g. the corners of rectangular hollow sections). Note also that the increase in strength is dependent on the method of manufacture. For example, Gardner found that sections fabricated (from annealed material) by first forming the material into a circular hollow section, and then shaping it into a rectangular hollow section showed moderate strength enhancements in the flat regions and large enhancements in the corners. By comparison, sections fabricated by direct bending from a flat sheet had essentially unchanged properties in the flat regions, with large strength enhancements at the corners (but not as large as the enhancement with the indirect fabrication method)¹⁵.

Strain-rate sensitivity

Most investigations of strain-rate effects have been concerned with fast strain-rates and have concentrated primarily on the plastic deformation region^{21,22,23,24}. Typical stress-strain plots for 1.4307²² and 1.4404²⁴ at room temperature are given in Figure C.3.6. More recent test results are shown in Figure C.3.7 and Figure C.3.8²⁵. (The cyclic fluctuations in the 0 to 20% strain range in these latter two Figures are due to the dynamic response of the testing machine.) The Figures show that stainless steels have a strong strain rate dependency; strengths are increased (particularly in the region of the 0,2% proof strain) and the rupture strain reduced at higher strain rates. In the design of stainless steel blast walls, where the predominant loading is at a high strain rate, it is customary to apply a strain rate enhancement factor to the design strength in order to take advantage of the increase in strength at higher strain rates.

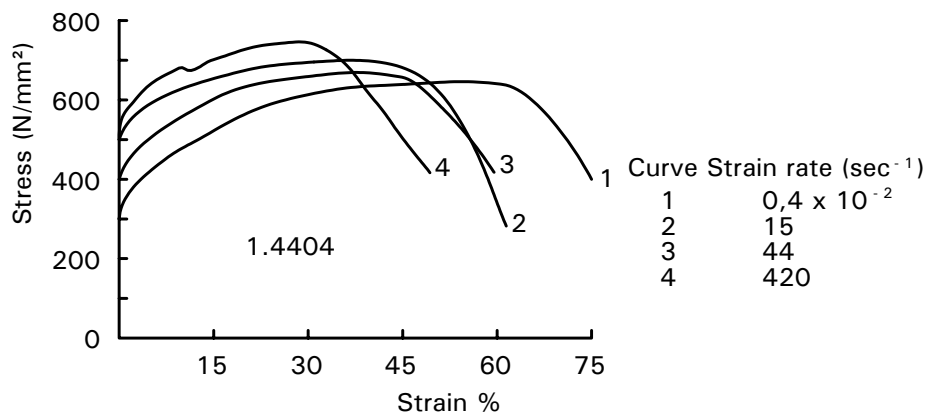
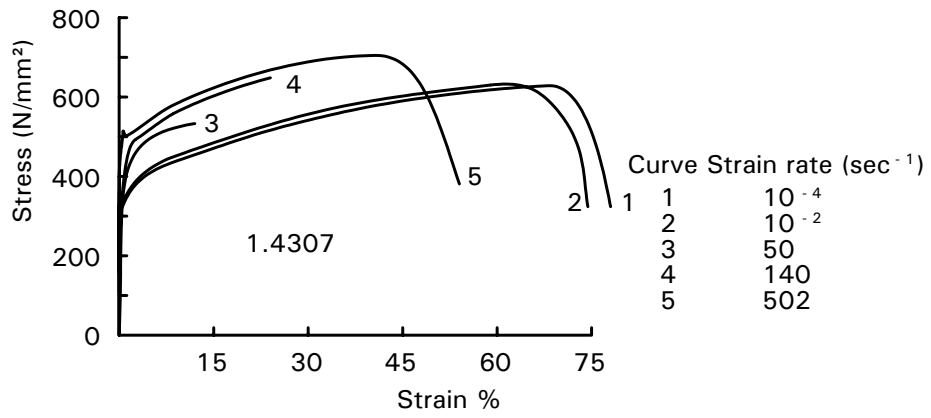

Figure C.3.6 Strain rate effects on grades 1.4307 and 1.4404

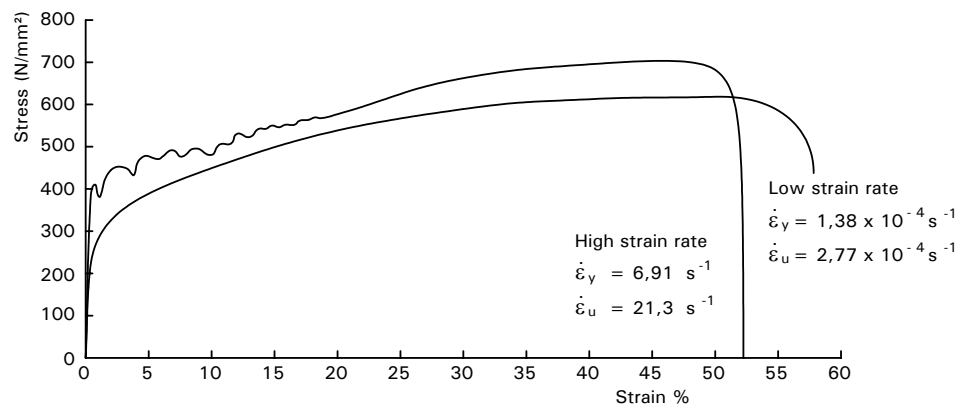

Figure C.3.7 Strain rate effects on grade 1.4404

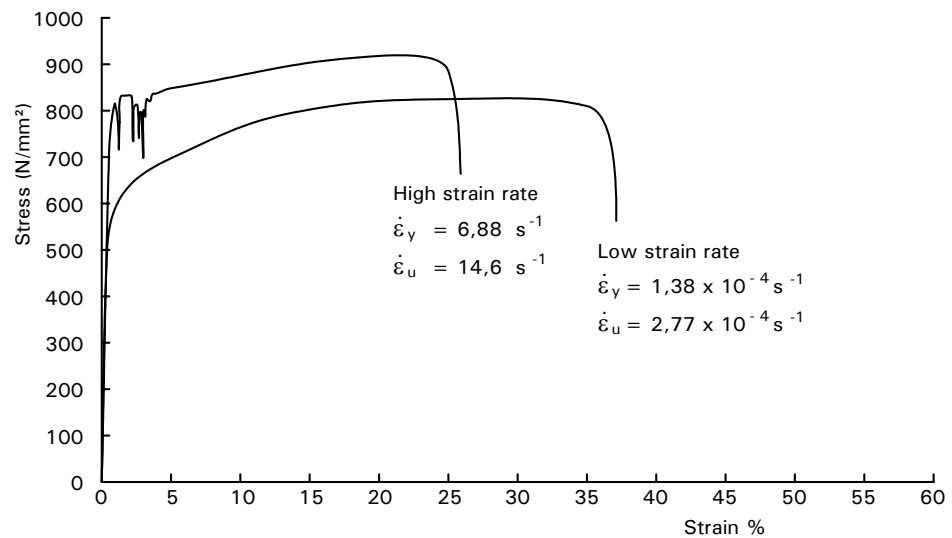

Figure C.3.8 *Strain rate effects on grade 1.4462*

Rather fewer investigations have examined the behaviour under slow strain-rates. The most well-known work is due to Krempl²⁶, in which annealed type 1.4301 stainless steel was tested at strain-rates of 10^{-3} , 10^{-5} and 10^{-8} per second (note the maximum equivalent strain-rate allowed in specifications is usually $1,5 \times 10^{-4}$ per second). The decreases in the measured 0,2% proof stress due to a change in strain-rate from 10^{-3} to 10^{-5} per second and from 10^{-3} to 10^{-8} per second are about 15% and 30% respectively, i.e. averages per order change of strain-rate of 7,5% and 6% respectively.

In the tests carried out specifically for the First Edition of this Design Manual¹², constant stress-rates of 0,3 to 30 N/mm² per second were used. These correspond to strain-rates, in the elastic region, of $1,5 \times 10^{-6}$ and $1,5 \times 10^{-4}$ per second. Although an order change of stress rate gave, in isolated instances, a 6% change in the 0,2% proof stress, on average it was approximately 4%. This average figure applies equally to the three materials tested (1.4307, 1.4404 and duplex 1.4462) and would appear, on the evidence, to apply equally to the longitudinal and transverse directions and to tension or compression.

It should be noted that a constant strain-rate and a constant stress-rate are not equivalent past the proportional limit, even if they correspond to the same rate in the elastic region. A constant stress-rate will give ever increasing equivalent strain-rates as loading continues, since plastic straining does not contribute to stress. Thus constant stress rates generally will lead to higher measured proof stresses than constant strain-rates. This effect disappears at temperatures above about 200°C, as can be seen in Figure C.3.9 for grade 1.4401 material.

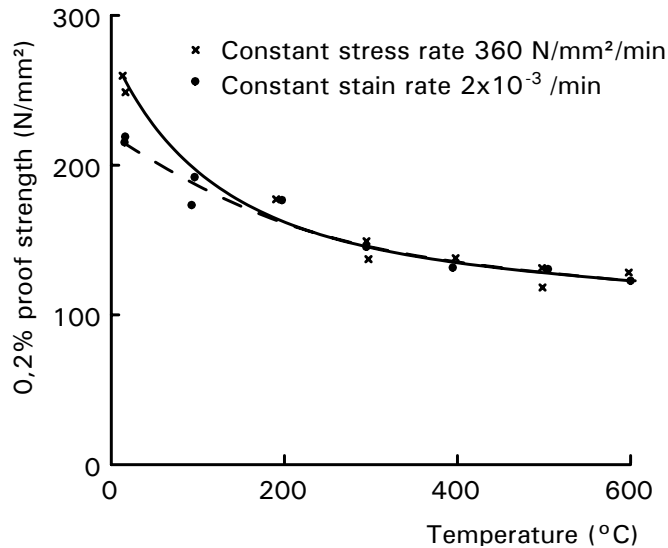

Figure C.3.9 *Effect of loading procedure on the 0,2% proof stress*

C.3.2.3 Typical values of properties

For the First Edition of the Design Manual, mill data was collected and analysed from several European stainless steel producers

C.3.2.4 Design values of properties

Flat products

Three options are offered for defining the design strength. Options (ii) and (iii) can only be used if the actual material to be used in the structure is identified and available at the time of design; however, these options will generally give the more economical use of material.

Fasteners

It is important that connections in steelwork are ductile at the Ultimate Limit State. For this reason it is traditional to have high factors of safety associated with fasteners. In ENV 1993-1-1 the factor of safety is approximately 1,9 to 2,1, the effects of prying action being explicitly calculated.

The ASME Boiler and Pressure Vessel code¹ is based on allowable stresses and specifies a factor of safety of 3,33 against tensile fracture of austenitic bolts. This seemingly high value is presumably to allow primarily for the effects of temperature, the effects of prying action being explicitly calculated. The ASCE stainless steel code²⁷ gives a somewhat lower factor of safety of 1,55 to 1,77 which includes an allowance for the effects of prying action.

The provisions in ENV 1993-1-1 should give a satisfactory factor of safety against tension failure for stainless steel bolts, especially as stainless steel is more ductile than normal structural bolt materials. Therefore the resistance of fasteners should be based on the ultimate tensile strength of the material as in ENV 1993-1-1.

C.3.3 Physical properties

Compared to carbon steels, the higher coefficients of thermal expansion for the austenitic steels (e.g. 1.4301 and 1.4401), and the lower thermal conductivities, give rise to greater welding distortions, see Section 10.4.4 in the Recommendations.

Cold working produces phase transformation (see C.3.2.2). These strain induced phases are magnetic and thus cold worked austenitic stainless steels generally have different magnetic properties from those in the annealed condition. However, unless the application is critical, moderate amounts of cold working may still provide adequate magnetic properties. Annealing has the effect of reversing the phase transformation and thus restoring the non-magnetic properties.

C.3.4 Effects of temperature

Other properties to be considered in elevated temperature applications include creep strength, rupture strength, scaling resistance, etc. Useful information on these and other properties may be found in References 4, 28 and 29. Information for cryogenic applications may be found in References 4, 29 and 30.

C.3.5 Selection of materials

C.3.5.1 Grades

Table 3.6 in the Recommendations is extracted from Reference 31, which also considers other types of stainless steel. It is based on long term exposure of stainless steel sheet samples at a variety of locations.

For environments other than atmospheric, it is advisable to seek the advice of a corrosion engineer or obtain information from stainless steel producers. Reference 32 gives some details of service experience obtained in the following industries:

- Oil and gas industry;
- Food and beverage industry;
- Pharmaceutical industry;
- Power industry;
- Pulp and paper industry;
- Automotive industry;
- Shipping and aerospace industry.

C.3.5.2 Availability of product forms

Table C.3.2 and Table C.3.3 give the standard and special finishes available, taken from EN 10088-2⁵. Note that the finer the finish, the higher the fabrication cost; see Section 10.6 of the Recommendations. Further guidance on finishes is also available^{33,34}.

When investigating product availability, it may be prudent to check delivery times.

Table C.3.2 *Type of process route and surface finish for sheet, plate and strip: standard finishes¹⁾*

Abbreviation in EN 10088-2 ²⁾	Type of process route	Surface finish	Notes
1U	Hot rolled, not heat treated, not descaled	Covered with the rolling scale	Suitable for products which are to be further worked, e.g. strip for rerolling
1C	Hot rolled, heat treated, not descaled	Covered with the rolling scale	Suitable for parts which will be descaled or machined in subsequent production or for certain heat-resisting applications.
1E	Hot rolled, heat treated, mechanically descaled	Free of scale	The type of mechanical descaling, e.g. coarse grinding or shot blasting, depends on the steel grade and the product, and is left to the manufacturer's discretion, unless otherwise agreed.
1D	Hot rolled, heat treated, pickled	Free of scale	Usually standard for most steel types to ensure good corrosion resistance; also common finish for further processing. It is permissible for grinding marks to be present. Not as smooth as 2D or 2B.
2H	Work hardened	Bright	Cold worked to obtain higher strength level.
2C	Cold rolled, heat treated, not descaled	Smooth with scale from heat treatment	Suitable for parts which will be descaled or machined in subsequent production or for certain heat-resisting applications.
2E	Cold rolled, heat treated, mechanically descaled	Rough and dull	Usually applied to steels with a scale which is very resistant to pickling solutions. May be followed by pickling.
2D	Cold rolled, heat treated, pickled	Smooth	Finish for good ductility, but not as smooth as 2B or 2R.
2B	Cold rolled, heat treated, pickled, skin passed	Smoother than 2D	Most common finish for most steel types to ensure good corrosion resistance, smoothness and flatness. Also common finish for further processing. Skin passing may be by tension levelling.
2R	Cold rolled, bright annealed ³⁾	Smooth, bright, reflective	Smoother and brighter than 2B. Also common finish for further processing.
2Q	Cold rolled, hardened and tempered, scale free	Free of scale	Either hardened and tempered in a protective atmosphere or descaled after heat treatment.

Notes:

1) Not all process routes and surface finishes are available for all steels

2) First digit, 1 = hot rolled, 2 = cold rolled

3) May be skin passed

Table C.3.3 *Type of process route and surface finish for sheet, plate and strip: special finishes¹⁾*

Abbreviation in EN 10088-2 ²⁾	Type of process route	Surface finish	Notes
1G or 2G	Ground	⁴⁾	Grade of grit or surface roughness can be specified. Unidirectional texture, not very reflective.
1J or 2J	Brushed or dull polished	Smoother than ground. ⁴⁾	Grade of brush or polishing belt or surface roughness can be specified. Unidirectional texture, not very reflective. Typically specified for internal applications.
1K or 2K	Satin polish	⁴⁾	Additional specific requirements to a 'J' type finish, in order to achieve adequate corrosion resistance for marine and external architectural applications. Transverse $R_a < 0.5 \mu\text{m}$ with clean cut surface finish. Typically specified for external applications.
1P or 2P	Bright polished	⁴⁾	Mechanical polishing. Process or surface roughness can be specified. Non-directional finish, reflective with high degree of image clarity.
2F	Cold rolled, heat treated, skin passed on roughened rolls	Uniform non-reflective matt surface	Heat treatment by bright annealing or by annealing and pickling.
1M	Patterned	Design to be agreed, second surface flat	Chequer plates used for floors
2M			A fine texture finish mainly used for architectural applications
2W	Corrugated	Design to be agreed	Used to increase strength and/or for cosmetic effect.
2L	Coloured ³⁾	Colour to be agreed	
1S or 2S	Surface coated ³⁾		Coated with e.g. tin, aluminium, titanium

Notes:

- 1) Not all process routes and surface finishes are available for all steels
- 2) First digit, 1 = hot rolled, 2 = cold rolled
- 3) One surface only, unless specifically agreed at the time of enquiry and order
- 4) Within each finish description, the surface characteristics can vary, and more specific requirements may need to be agreed between manufacturer and purchaser (e.g. grade of grit or surface roughness)

C.3.6 Durability

C.3.6.1 Introduction

Although stainless steel will perform satisfactorily in the great majority of applications, there are potential difficulties with corrosion mechanisms in specific environments. It is the intention of Section 3.6 in the Recommendations to bring to the designer an awareness of these mechanisms and the possible pitfalls in the application of stainless steel, without being unduly alarmist. Good design will avoid potential problems.

C.3.6.2 Types of corrosion

The corrosion resistance of stainless steel arises from a passive, chromium-rich, oxide film that forms on the surface of the steel. The film is strongly adherent, usually self-repairing, and generally highly resistant to chemical attack. If it is broken down and not repaired, corrosion will occur.

The presence of oxygen is essential to the corrosion resistance of a stainless steel. The corrosion resistance is at its maximum when the steel is boldly exposed and the surface is maintained free of deposits by a flowing bulk environment (e.g. rainwater). Covering a portion of the surface, for example by biofouling, painting, or installing a gasket, produces an oxygen-depleted region under the covered region, and a higher level of alloy content is required to prevent corrosion.

Molybdenum is used to increase the stability of the film and thus grades 1.4401 and 1.4404 exhibit greater corrosion resistance than grades 1.4301 and 1.4307. Duplex 1.4462 is even better in terms of corrosion resistance.

General (uniform) corrosion

Passivity exists under certain conditions for particular environments. When conditions are favourable for maintaining passivity, stainless steels exhibit extremely low corrosion rates. If passivity is destroyed under certain conditions that do not permit the restoration of the passive film (as may occur in strongly acid or alkaline environments), stainless steel will corrode, much like a carbon or low alloy steel.

The corrosion rate in chemical environments can be expressed as either mass loss per unit surface area per unit time (normally $\text{g/m}^2\text{h}$) or thickness loss per unit time (normally mm/year). Iso-corrosion curves are available (e.g. Reference 35) for particular corrosive media that show constant rates of corrosion as a function of, for example, temperature and concentration. It should be noted that these curves can be significantly affected by impurities or additives in the medium.

Abrasive corrosion

Abrasive corrosion could occur, for instance, in flowing water containing suspended particles such as in some rivers, coastal areas, etc.

Pitting corrosion

Pitting initiation is influenced by surface conditions, including the presence of deposits, and by temperature. For a particular grade of stainless steel and a given environment, tests show that pitting will not initiate below a certain 'critical pitting temperature' (CPT). This, however, is of limited use when considering chloride-induced attack, as the corrosivity of a particular concentration of chloride solution can be greatly affected by other chemical

species. Also, very commonly, the chloride solution may be locally concentrated, such as occurs when evaporation takes place.

In short, for the types of environment for which this Design Manual was prepared, resistance to pitting is best characterised by service experience^{36,37}.

Crevice corrosion

A crevice will only present a corrosion hazard if it is wide enough to permit entry of a liquid and sufficiently narrow to maintain a stagnant zone. For these reasons crevice corrosion will usually only occur at openings a few tens of microns or less in width and rarely within gaps that are several millimetres wide. As with other types of corrosion, crevice corrosion cannot occur without a liquid corrodant; if the liquid is excluded from the crevice no trouble will occur.

It is therefore possible for some gaps, which may be defined as crevices, to be relatively safe but a precise decision is not really possible without experience of the situation involved and thus the general tendency is to recommend their elimination. It may be possible to seal crevices (see 3.6.4, *Design for corrosion control*).

As for pitting, a 'critical crevice temperature' similarly exists for this form of corrosion and which is specific to the geometry and nature of the crevice and the precise corrosion environment for each grade. Again, this can give a useful guide to preliminary alloy selection in chemical environments.

Intergranular corrosion (sensitisation)

The fact that the selected grades do not generally become sensitised is beneficial not only for intergranular corrosion but also for other forms of corrosion. This is because the low carbon content limits the amount of chromium that is precipitated out, leaving a relatively high amount in solution for imparting corrosion resistance.

Where service temperatures of more than 425°C are required, consideration should be given to the so-called stabilised grades. These grades, commonly designated 1.4541 and 1.4571, respectively have additions of titanium and niobium, which preferentially form carbide precipitates to chromium.

Bimetallic corrosion

Under certain circumstances, most metals can be vulnerable to this form of corrosion³⁸.

The severity of bimetallic corrosion depends on:

Potential difference

The greater the voltage between the metals (or other materials), the higher is the rate of corrosion. Figure C.3.10 shows the potentials of various materials in seawater at 10°C to 25°C, flowing at 2,5 to 4m/s³⁹.

Electrolyte

Increased conductivity of the electrolyte will raise the corrosion rate. Brackish waters and seawaters are very conductive. Fresh water can also be very conductive depending on the level of contaminants; rain can absorb atmospheric pollutants and may become conductive. The period of exposure to the electrolyte, including the effectiveness of drainage and evaporation and the retention of moisture in crevices, is an important parameter.

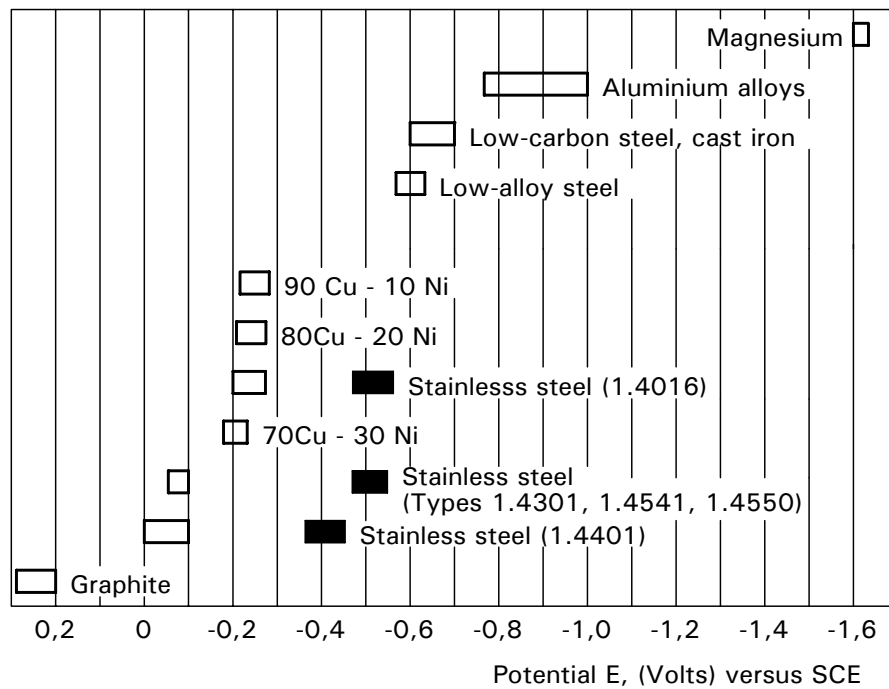

Figure C.3.10 *Corrosion potentials of various materials in flowing seawater; potentials are measured against saturated calomel electrode (SCE). The black bars indicate potential in low velocity or poorly aerated water and in shielded areas*

Condition of alloy

The changes in microstructure brought on by cold working or by the state of heat treatment can have a small effect on corrosion rates. There may be bimetallic corrosion between two different grades of stainless steel if there is a great difference in corrosion resistance. An example of this is at a welded joint where the alloy content of the filler metal is lower than that of the parent metal.

Area relationship

The rôle of area relationship is discussed in the Recommendations.

Stress corrosion cracking

It is difficult to predict when stress corrosion cracking (SCC) may occur but experience^{40,41} would suggest that it should certainly be considered for marine and other environments contaminated by chloride ions, as these are known to promote SCC.

As for other forms of corrosion the period of wetness (including that due to condensation) can affect SCC, as does the concentration of the damaging species (e.g. chloride). It should be noted that SCC can be caused by solutions having initially low chloride concentrations, even as low as parts-per-million levels. This is because the solution may become concentrated due to evaporation.

Duplex 1.4462 is much more resistant to SCC than the austenitic grades due to the presence of δ -ferrite which blocks the paths of the cracks. Relatively high amounts of δ -ferrite are required to be effective; around 50% δ -ferrite content is the optimum amount⁴². Naturally, the morphology and the distribution of the δ -ferrite, particularly at and within weldments, must be carefully controlled to achieve such benefits. This calls for adequate welding procedures to be utilised.

Detailed guidance on the use of stainless steel in swimming pool buildings, taking due regard of the risk of SCC, is available⁴³. A guidance note on SCC of stainless steels in swimming pool buildings, including preventative measures and inspection procedures, has also been recently published⁴⁴.

C.3.6.3 Corrosion in selected environments

General guidance is given in this section of the Recommendations and no further comment is given here.

C.3.6.4 Design for corrosion control

Many of the recommendations given in this section are simply a matter of good engineering practice and also apply to the design of carbon steel structures. However, they assume more importance with stainless steel structures.

Fabrication processes play an important part in corrosion resistance and reference should also be made to Section 10 in the Recommendations.

C.4 PROPERTIES OF SECTIONS

C.4.1 General

Section 4 of the Recommendations is concerned with the local behaviour of members; overall buckling is addressed in Section 5. For a member not subject to overall buckling, e.g. a stub column, the resistance (strength capacity) is solely dictated by local behaviour and therefore the provisions of Section 4 are sufficient for its determination.

The local capacity of a member, i.e. the cross-sectional resistance, is dependent on the resistances of the constituent elements that make up the cross-section. Elements, and hence the cross-section, may be affected by certain structural phenomena, such as local buckling and shear lag, which reduce their effectiveness to carry load. As in the case of carbon steel rules, these phenomena are catered for in the Recommendations by the use of effective widths.

In deriving the First Edition of the Design Manual in Section 4, carbon steel codes^{2,45,46}, stainless steel codes²⁷ and experimental data for stainless steel members have been consulted. When revising the Recommendations, further test data were available, generated in the *Development of the use of stainless steel in construction project*⁴⁷. In addition, the ENVs for cold formed carbon steel, fire resistant design, stainless steel and plated structures were also used^{18,48,49,50}.

C.4.2 Maximum width-to-thickness ratios

Limiting width-to-thickness ratios are provided for various types of elements. Limits are placed not so much that thinner sheets cannot be used but because the rules may become inaccurate. The ratios have been set as the smaller of the limiting values given in ENV 1993-1-3 for cold formed, thin gauge carbon steel⁴⁸ and the ASCE Cold Formed Stainless Steel specification²⁷.

It can be argued that at the low stresses associated with the high slendernesses, carbon and stainless steel elements should behave very similarly and thus justify the use of the greater ratios of ENV 1993-1-3 for all stainless steel elements. It is, however, considered prudent to use the values in Reference 27, where they are more limiting, due to the paucity of data relating to stainless steel and the fact that experience has already been gained with these values in a previous version of the American provisions.

The note concerning b/t ratios and visual distortion is based on Reference 27 and the b/t values are derived from the critical stress in the flange elements.

C.4.3 Classification of cross-sections

The classification of cross-sections according to their ability to resist local buckling and to sustain load with deformation has proved a useful concept for the design of carbon steel members and indeed for members of other metals (e.g. Ref. 51). Classification is usually defined in terms of a cross-section's moment capacity, i.e. whether it can reach the plastic moment (with and without rotation capacity), the elastic moment, or a lower value due to the onset of buckling.

As the definition of yield strength of non-linear materials is rather arbitrary, so are the definitions of yield and plastic moments for members composed of such materials. The obvious definitions to apply are the elastic and plastic section moduli multiplied by a proof stress, conventionally defined as the stress giving a 0,2% permanent strain. This is discussed further in C.4.7.

The cross-section's moment capacity is a function of the behaviour of the elements that constitute the cross-section.

Table 4.2 gives limiting width-to-thickness ratios for the classification of elements according to their type. The limiting ratios for Class 3 elements given in the table are derived from experimental stainless steel data whereas the limiting ratios for Classes 1 and 2 have been derived by making reference to other data and applying engineering argument.

In Table 4.2, the Class 3 limiting ratios for elements under pure compression are found when the reduction factor ρ in Section 4.4.1 is set equal to unity. Thus, for an internal element such as a web (for which the buckling factor $k_\sigma = 4$):

$$\rho = \frac{0,772}{\bar{\lambda}_p} - \frac{0,125}{\bar{\lambda}_p^2} = 1 \text{ and } \bar{\lambda}_p = \frac{d/t_w}{28,4\varepsilon\sqrt{k_\sigma}} = \frac{d/t_w}{56,8\varepsilon}$$

which solves to give $d/t_w = 30,7 \varepsilon$

The Class 3 limiting ratios for outstand elements under compression are similarly derived. The Class 3 limiting ratios for elements in bending, or bending and compression, are inferred from the pure compression values by using the buckling factor k_σ . For example, for the web element considered above in pure bending, $k_\sigma = 23,9$ and therefore the limiting ratio is calculated as:

$$d/t_w = 30,7\varepsilon \times \sqrt{23,9/4} = 75,0 \varepsilon$$

(A minor adjustment has been made in Table 4.2, in which the value is shown as 74,8, to remove inconsistencies arising from rounding errors in the factors given for combined bending and compression.)

The use of the buckling factor in the above manner, for deriving limiting width-to-thickness ratios for elements subject to a degree of bending, removes anomalies present in carbon steel codes (e.g. Refs. 2 and 45). These relate to the existence of vertical cut-offs in the design curve of the reduction factor, ρ for bending elements in the carbon steel codes. In effect, the limiting ratios are increased in the carbon steel codes when bending is present. A similar increase may, in fact, also be applicable to stainless steel elements in bending, but there are no available data to support or to quantify this.

There are insufficient data to establish experimentally the Class 1 and Class 2 limiting ratios for stainless steel. However, numerical and experimental studies^{52,53,54} on element load/end-shortening behaviour confirm that strain hardening materials exhibit longer plateaus and less steep unloading characteristics than non-hardening materials such as carbon steel.

Thus, if a carbon steel element may be classified as a Class 1 element, then a stainless steel element of the same slenderness will have at least as great a deformation capacity and likewise be classified as Class 1. It may be noted that

with lower Class 3 limits, but with the same Class 1 limits, a smaller range between Class 1 and 3 exists for stainless steel than for carbon steel. There even exists the possibility that Classes 1 and 2 could collapse to a single class for stainless steel, though this potential simplification is left for future research.

In the absence of suitable data, a prudent approach has been taken in defining the Class 1 and 2 limits for stainless steel. Starting with outstand elements, the Class 1 limits for compression are the same as given for carbon steel in ENV-1993-1-1. The Class 2 limits are set in the same proportions between the Class 1 and Class 3 limits that apply to carbon steel in ENV 1993-1-1. For internal elements in compression, the Class 1 limits for carbon steel are already higher than those for Class 3 stainless steel elements. This is evidence for the collapse of classes for strain hardening materials referred to above. For these elements, therefore, the Class 1 and Class 2 limits for stainless steel were derived using the same proportions pertaining to outstand elements in compression.

The Class 1 and 2 limits in bending were established from the compression limits by applying the same factors that relate the carbon steel limits in ENV 1993-1-1 to each other. Finally, for Class 1 and 2 stainless steel elements under combined bending and compression, suitable interaction formulae were established having the same form (linear, reciprocal functions, etc) as used in ENV 1993-1-1 for carbon steel.

Since there is no sharply defined yield point, placing cross-sections into discrete behavioural classes is less appropriate for stainless steel than it is for carbon steel. Gardner¹⁵ has proposed a continuous method of cross-section classification and member design: using a more appropriate material model, member strengths are assessed using a local buckling strength derived from the deformation capacity of the cross-section. It can be viewed as a continuous method of section classification and member design.

C.4.4 Effective widths

C.4.4.1 Effective widths of elements in Class 4 cross-sections

The use of effective widths and effective cross-sections is well established for the structural design of Class 4 cross-sections. The concept is illustrated in Figure C.4.1 for an internal element under pure compression. In general, rules are required for calculating both the magnitude of the effective width as a function of element slenderness and stress distribution, and on how the effective width is distributed over the element. For the simple case in Figure C.4.1, the effective width is distributed as two equal zones, located at each unloaded edge of the element. Tables 4.3 and 4.4 give distribution rules for other cases and are the same as those used in ENV 1993-1-1.

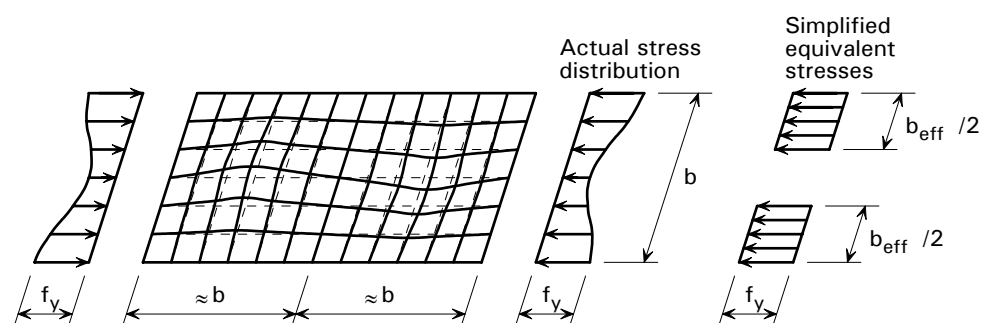

Figure C.4.1 The effective width concept

The effective width is normally found by applying a reduction factor, ρ , to the full width. An examination of the reduction factor given by Winter⁵⁵ for carbon steels as embodied in ENV 1993-1-1 (and, incidentally, in the UK aluminium code) and the American stainless steel code²⁷ has found it unsatisfactory for use with stainless steel. Rather, three separate expressions have been derived for various types of elements (cold formed or welded; internal; or outstand) by fitting characteristic curves to experimental data.

The curves are expressed in the form $\rho = \frac{a}{\bar{\lambda}_p} - \frac{b}{\bar{\lambda}_p^2}$ where a and b are constants and $\bar{\lambda}_p$ is a non-dimensional plate slenderness. The form in which these curves are expressed was modified in this Second Edition to resemble more closely the corresponding expression in the forthcoming EN 1993-1-5⁵⁶.

The $\bar{\lambda}_p$ parameter has been proven numerically, as well as experimentally, to be suitable for (non strain hardening) carbon steel elements. It is not strictly accurate for strain hardening materials where the 'yield' strength is given in terms of an offset proof strength (as used throughout this Design Manual); rather a secant proof strength should be used⁵³. However, it has been shown⁵⁷ that the offset proof strength gives sufficiently accurate results for design purposes, even for materials having a wide range of E values and yield strengths. In particular, Reference 58 describes one series of tests on magnesium, aluminium and stainless steel alloys with 0,2% proof strengths ranging from 184 to 1340 N/mm²; the results are closely banded with $\bar{\lambda}_p$ based on the 0,2% proof strength.

The recommended curves, and their experimental basis, are described below:

Cold formed elements - Internal elements

Two sources of data exist for cold formed internal elements. Johnson and Winter⁵⁹ tested ten flexural hat members in grade 1.4301 material. Only four tests were reported in sufficient detail to allow the effective widths to be assessed. The sheet thicknesses used for these four tests were 0,78 and 1,25 mm. In Figure C.4.2 only the effective widths at the maximum applied loads are shown; these are not necessarily the ultimate loads. Nine internal element tests were carried out by Wang and Winter⁶⁰ of which seven tests were for members in flexure and two for members in compression. Beam materials included grade 1.4310 (formerly known as grade 301) (½ hard) in thicknesses 0,83 to 1,6 mm and grade 1.4301 of thickness 0,8 mm. Column materials were grade 1.4310 (½ hard) in thicknesses 8,2 mm and 15,7 mm. It may be noted that the 1.4310 (½ hard) grade had pronounced anisotropy. The results shown in Figure C.4.2 include sub-ultimate values found by substituting the yield strength in $\bar{\lambda}_p$ by the measured edge stress. Superimposed on the experimental data are the carbon steel curve from EN 1993-1-5 and the recommended curve for stainless steel given by Equation 4.1a in the Recommendations. The inclusion of the elastic data shows that the recommended curve is valid for subcritical stresses.

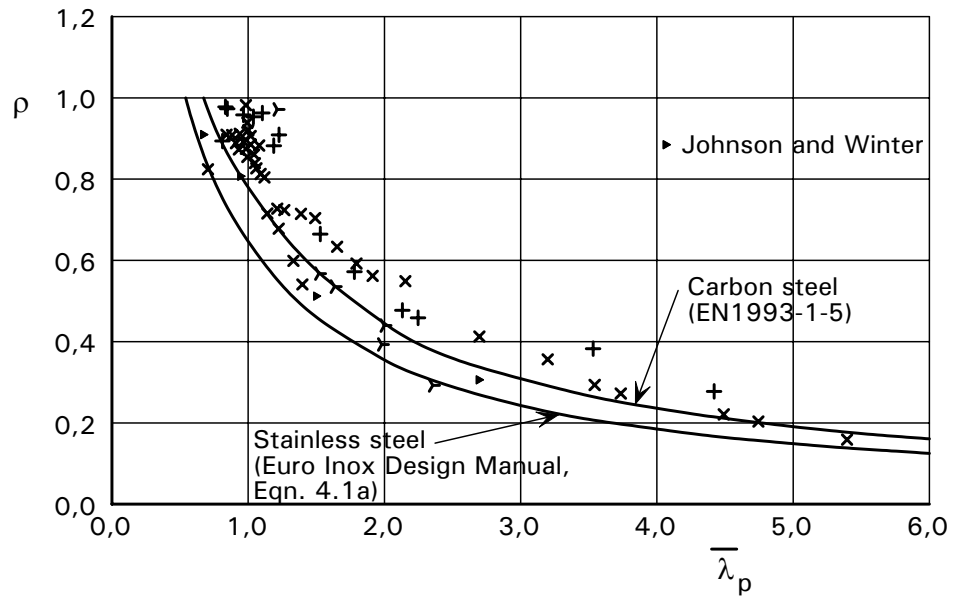

Figure C.4.2 *Reduction factor versus plate slenderness for cold formed internal elements*

Cold formed elements - Outstand elements

Johnson and Winter⁶¹ tested sixteen columns, each comprising two channels, glued back-to-back, brake pressed from 1.4301 material nominally 0,9mm thick. Wang and Winter⁶⁰ carried out four tests on similar columns but in nominally 0,83mm thick 1.4310 (½ hard) material. The results, again including sub-ultimate values, are shown in Figure C.4.3. A design curve for stainless steel lying very close to the EN 1993-1-5 curve for carbon steel is recommended.

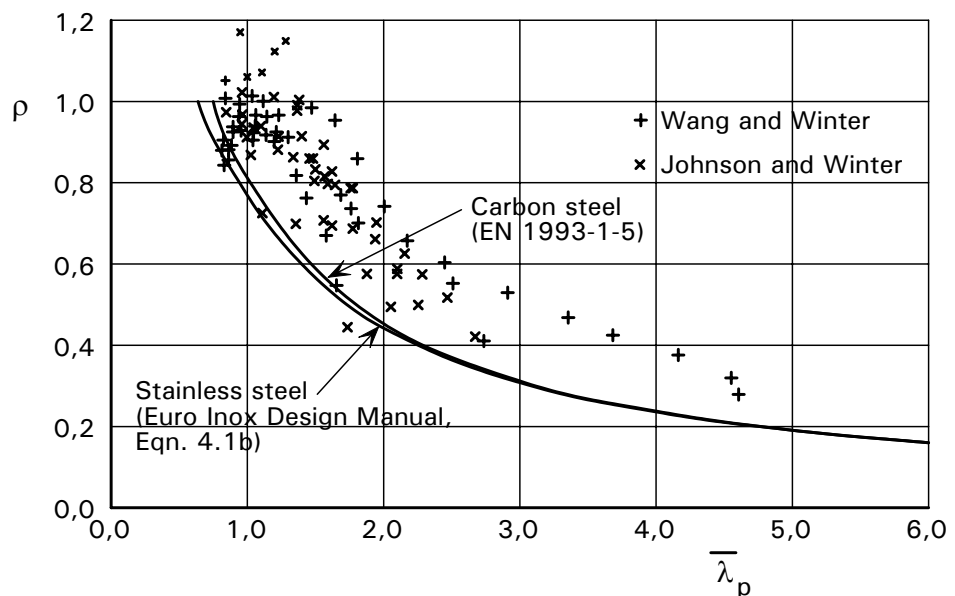

Figure C.4.3 *Reduction factor versus plate slenderness for cold formed outstand elements*

Welded elements

Only one series of tests is known in which local buckling of welded stainless steel elements is considered⁶². Twenty four stub columns, with various permutations of flange and web slendernesses, were fabricated in 1.4301 type materials of 2 and 3 mm thicknesses. It is not possible to evaluate how the load is shared between the flanges and web in any one test but it may be assumed

that it is in the same ratio that is calculated from a design line, say the EN 1993-1-5 curve for carbon steel. For an individual test this does not yield any further useful information but when several results are processed, involving specimens of various combinations of flange and web slendernesses, a pattern emerges. It is particularly useful when the average value of the inferred reduction factors pertaining to each web or flange slenderness is considered. The results obtained with this procedure, more fully detailed in Reference 63, are shown in Figure C.4.4.

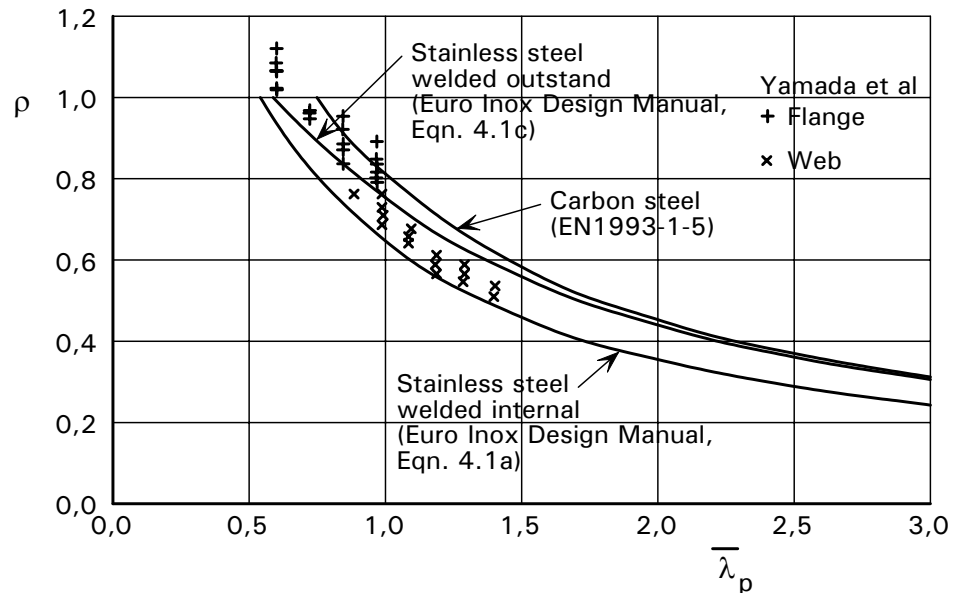

Figure C.4.4 Reduction factor versus plate slenderness for welded elements

Superimposed on the figure are: (a) the EN 1993-1-5 design curve for carbon steel elements, (b) the recommended stainless steel internal element curve discussed above for cold formed elements, which is to be compared with the web data, and (c) the recommended curve for welded stainless steel outstands, which is to be compared with the flange data. It is seen that the recommended internal element curve appears satisfactory for both cold formed and welded elements. However, the data supports that cold formed and welded outstands should be treated differently. This is partially recognised for carbon steel outstands where different Class 3 limits are given in ENV 1993-1-1, i.e. different vertical cut-off lines are used, though only one design curve is applied.

C.4.4.2 Effects of shear lag

Shear lag is a phenomenon that has been widely studied in the context of aeronautical, ship and bridge structures⁶⁴. Rather fewer studies have examined the problem of interaction effects between shear lag and local buckling. Although no work is known which specifically looks at the effects of strain hardening on shear lag behaviour, studies on elements under combined shear and compression^{52,65} would suggest that no significant difference exists between hardening and non-hardening materials.

The formulation provided in the recommendations are based on the ideas of Burgan and Dowling⁶⁶ which are simple to apply yet reasonably accurate. Their ideas have been extended to cover tension flanges and outstand flanges. The k factor introduced for outstand flanges is based on BS 5400 Part 3⁶⁷ which itself is based on work by Moffat and Dowling⁶⁸. In this Second Edition, specific

expressions for the shear lag effective breadth ratio for serviceability limit state calculations were added.

Note that the distance b (or c) should include any lips or cold formed intermediate stiffeners. For stiffeners comprising flats or Tees welded to the plate, and stiffened plating in general, reference should be made to other sources (e.g. Refs. 66 and 67) to establish effective breadths.

C.4.4.3 Flange curling

When a beam is subject to bending, the out-of-plane stress components arising from flange curvature deflect those parts of the flange remote from the web towards the neutral axis. This gives rise to flange curling as illustrated in Figure C.4.5. It only becomes significant for unusually wide thin flanges or where the appearance of the section is important.

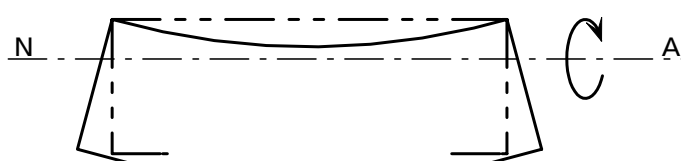

Figure C.4.5 Deformations in flange curling

The formula given in the recommendations is based on the derivation given by Yu⁶⁹ for internal flange elements, for which the constant is 2,28. For outstand flange elements, the constant is calculated as 1,37 and advantage may be made of this in marginal cases. However, prEN 1993-1-3⁷⁰ recommends a constant of 2 and the non-linear nature of stainless steel, which may increase the amount of curling, should be borne in mind.

C.4.5 Stiffened elements

Guidance is given to ensure that edge stiffeners are adequate if a flange is to be treated as an internal element, see Figure C.4.6. For intermediately stiffened internal flange elements, only those stiffeners that are adjacent to a web may be considered to be effective. If three or more stiffeners are used, the central stiffener(s) would have two or more flat sub-elements between itself and the nearest shear transmitting element (i.e. a web) and hence could prove ineffective.

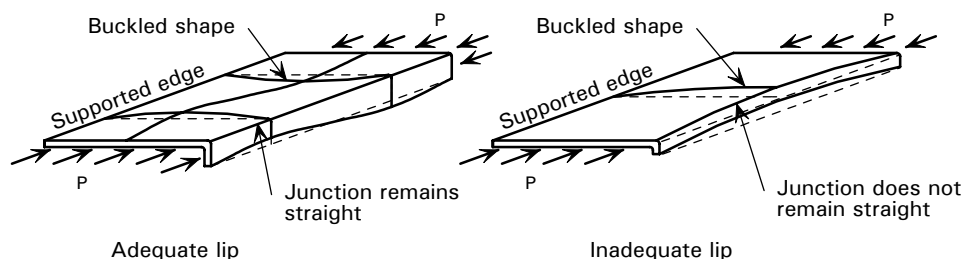

Figure C.4.6 Adequate and inadequate lips

Talja⁷¹ carried out single span tests on three different stainless steel trapezoidal sheeting profiles (unstiffened, one stiffener in the flanges, one stiffener in the flanges and two in the webs). The mean value of the plate thickness was 0,61 mm. The bending resistance of the sheeting was determined under gravity loading and uplift. Further tests were subsequently carried out on profiles of thickness 0,5 and 0,8 mm⁷². The test results were compared with the resistances predicted by ENV 1993-1-3; good agreement was found, so it was

concluded that the guidance for carbon steel is applicable to stainless steel. The guidance in Section 4.5.3 is taken from ENV 1993-1-3. Note that the effective width formulae for stainless steel given in Section 4.4.1 should be used when assessing the effectiveness of stiffeners.

C.4.6 Calculation of section properties

Cross section properties are used to calculate member slendernesses for overall buckling; net areas are used for local tensile strength; and the effective section is used for local and member buckling resistance of Class 4 cross-sections.

Being material independent, the geometric properties of a stainless steel section may be calculated by the same formulae as used for carbon steel members. Nevertheless, when considering thin gauge cold formed sections, some formulae and techniques may be unfamiliar, due to the nature of these products. This particularly applies to linear methods of calculation (in which the properties of line elements are multiplied by the sheet thickness to derive cross-section properties), and to the calculation of the warping constant. For the former, a good source of information is the AISI cold formed specification⁷³ and, for the latter, standard texts (e.g. References 69 and 74) may be consulted.

The simplifications given in the Recommendations for ignoring or approximating the rounding of corners are as given in ENV 1993-1-3⁴⁸.

The recommendations given in Section 4.6.4 for calculating the net area follow those given in carbon steel codes² except for the inclusion of a reduction factor (k_A) for hole eccentricity effects. The verification of the essentially carbon steel rules for use with stainless steel is based on 9 tests on tension members containing holes in various configurations and 6 bolted connection tests which failed at the net section. Further details of the tension member tests and the derivation of the reduction factor k_A may be found below, and that of the bolted connection tests in C.6.2.3.

The results from the two test series are shown in Figure C.4.7 where they are compared with the recommended design line (with γ_M set to unity) for members subject to tension (see 4.7.2 and 6.2.3 in the Recommendations). Although the test results fell close to the line of unit slope, the First Edition of the Design Manual included a 0,9 factor in the expression for N_u for the following reasons:

- To account for variables such as strain rate effects.
- To maintain compatibility with ENV 1993-1-1.
- To limit gross deformation at the net section.

The tension member specimens were sheared from 5,03mm thick 1.4307 material ($f_u = 777 \text{ N/mm}^2$) and the results of these tests are summarised in Table C.4.1. The zig-zag failure mode III in Figure C.4.8 was not observed⁷⁵.

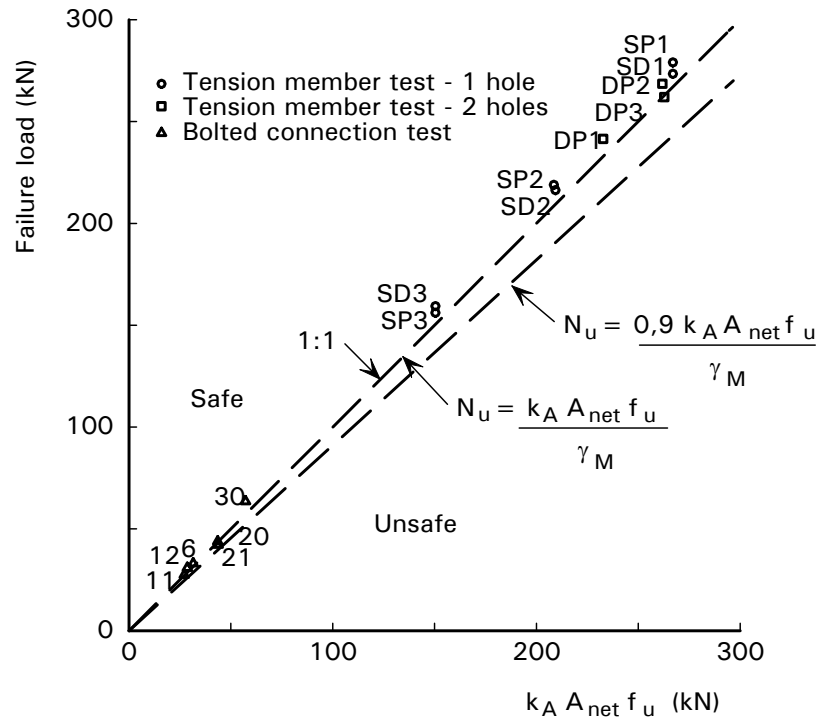

Figure C.4.7 Net section failure data ($\gamma_M = 1,0$)

Table C.4.1 Summary of net section test specimens

Specimen ¹⁾	Width (mm)	Diameter of Hole(s)	Failure Mode ²⁾	Failure Load (kN)	Failure Load / ($k_A A_{net} f_u$)
SP1	90,6	22,0	I	279	1,040
SD1	90,6	22,0	I	273	1,019
SP2	75,4	22,0	I	219	1,049
SD2	75,6	22,1	I	217	1,033
SP3	60,6	22,0	I	157	1,040
SD3	60,6	22,0	I	159	1,054
DP1	85,9	13,0	II	241	1,029
DP2	85,8	13,0	IV	269	1,022
DP3	85,9	13,0	IV	262	0,994

1) S (single hole specimen) or D (double hole specimen)
P (punched hole) or D (drilled hole)

2) See Figure C.4.8

The results in Table C.4.1 suggest no significant difference between punched and drilled holes. There are two possible explanations for the experimental failure loads being greater than the net area times the ultimate strength of the material. Firstly the shearing of the specimens work hardened the edges. Secondly, and more importantly, there was a strain rate effect as straining would have been much faster at the net section than along the gross section (the ultimate tensile strength quoted above corresponds to the rate applied to the gross section).

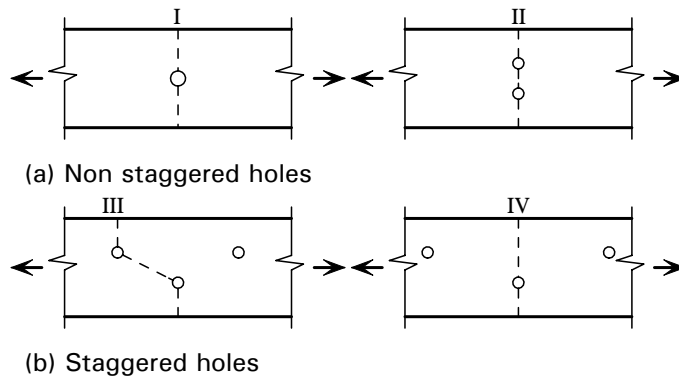

Figure C.4.8 Net section failure modes

The reduction factor, k_A , is to be applied to eccentric holes such as shown for failure mode IV in Figure C.4.8. Given a specimen width and hole diameter, it is to be expected that the failure load for mode IV should be lower than for mode I, due to hole eccentricity. The relationship $k_A = 1 - d_0/b (1 - 2e/b)$ has been derived⁷⁵ by examining the effect of the local moment (due to the eccentric hole) in reducing the tensile resistance. Both plastic stress block and linear stress distribution analyses were undertaken. Although the analyses were crude, for example the stress concentration at the hole was ignored, it is likely that they gave a reasonable indication of the shape of the interaction surface (with variables d_0/b and e/b), see Figure C.4.9. The shape is well approximated by the recommended k_A relationship which also reasonably predicts the two reduction factors for specimens DP2 and DP3 ($d_0/b = 0,151$, $e/b = 0,25$) obtained as the ratios of the respective right hand entry in Table C.4.1 to the mean of the entries for the other specimens.

Without the reduction factor, specimen DP3 would have been predicted to fail in mode III and the factors on the right of Table C.4.1 for specimens DP2 and DP3 would have been 0,945 and 0,965 respectively. No doubt carbon steel rules should also contain similar provisions for the effect of eccentric holes.

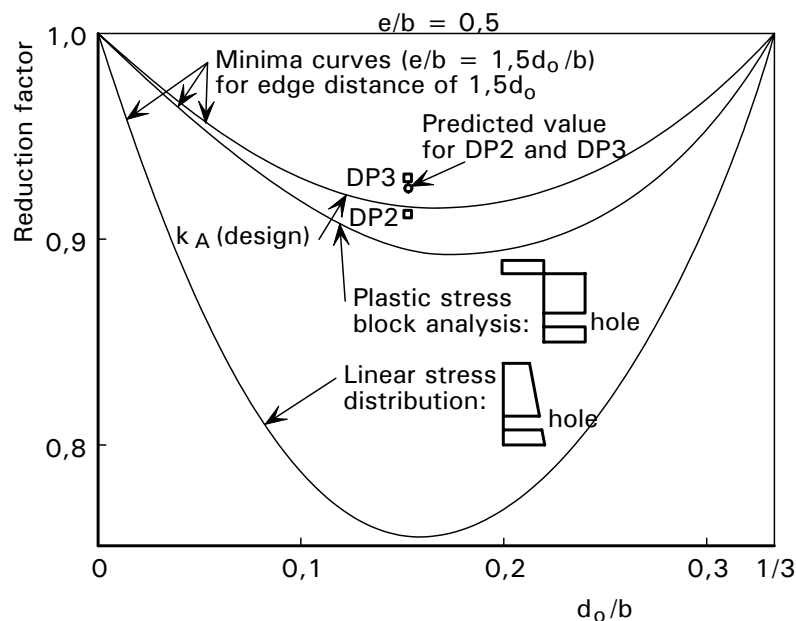

Figure C.4.9 Minima curves for k_A for holes at the edge distance of $1,5d_0$

C.4.7 Resistance of cross-sections

The resistance of a cross-section under various forces and moments, as given in 4.7.2 to 4.7.6 inclusive, is limited either by plasticity or local buckling. The formulae are generally based on ENV 1993-1-1² and follow common sense.

For cross-sections in bending, the appropriate second moment of area (W_{pl} , W_{el} or W_{eff}) must be taken for the neutral axis about which the moment acts.

Class 4 cross-sections which are not doubly symmetric will, under external compression, experience a shift in the neutral axis giving rise to a secondary moment. These sections should thus be assessed using the provisions of 4.7.6. The shift in the neutral axis depends on the effective widths, which themselves depend on the assumed stress distribution across the cross-section. To avoid undue iteration, the provisions in Section 4.4.1 should be used; these are based on studies carried out for carbon steel members⁷⁶.

The expression for the ultimate resistance of the net cross-section at holes for fasteners contains a new parameter, k_r , which is discussed in Section C.6.2.3.

The potential benefits of taking the strain hardening properties of stainless steel into consideration are recognised in 4.7.7.

It has already been noted in the commentary to Section 4.3 that the proof stress is conventionally defined. For structural purposes, the 0,2% proof stress is normally used, whereas the 1% proof stress is favoured for pressure vessels; pressure vessels do not usually suffer from instability and changes in overall diameter are acceptable. Therefore, if a structure is not subject to instability and deformations are not critical, larger proof stresses than the 0,2% value should be permissible. The difficulty is to define to what degree strain hardening can be utilised. For extremely stocky members, this could be high but a lack of suitable data does not permit precise guidance to be given.

For the First Edition of the Design Manual, a limit of 1,2 times the 0,2% proof stress for the design strength was suggested. This was based on the results of the beam tests carried out for the First Edition of the Design Manual⁷⁷. In these tests, Class 3 and Class 4 cold formed and welded beams exceeded the enhanced plastic moment ($1,2 f_{0,2} W_{pl}$). The fact that the Class 3 and even the Class 4 cross-sections exceeded M_p is a reflection of the variability of test data. The results, shown in Figure C.4.10, also support the suspicions concerning the collapse of classes mentioned in C.4.3. It should be noted that for the particular material (6,3 mm thick 1.4404), 1,2 times the 0,2% proof stress corresponds approximately to the 1% proof stress. Thus, large deformations should be expected where enhanced strength is to be taken. The limit of 1,2 times the proof strength in Section 4.7.7 was removed in the Second Edition of the Design Manual, on the basis that it was unnecessarily conservative for certain situations.

Enhanced strength should not be used for long term loading, because of creep considerations.

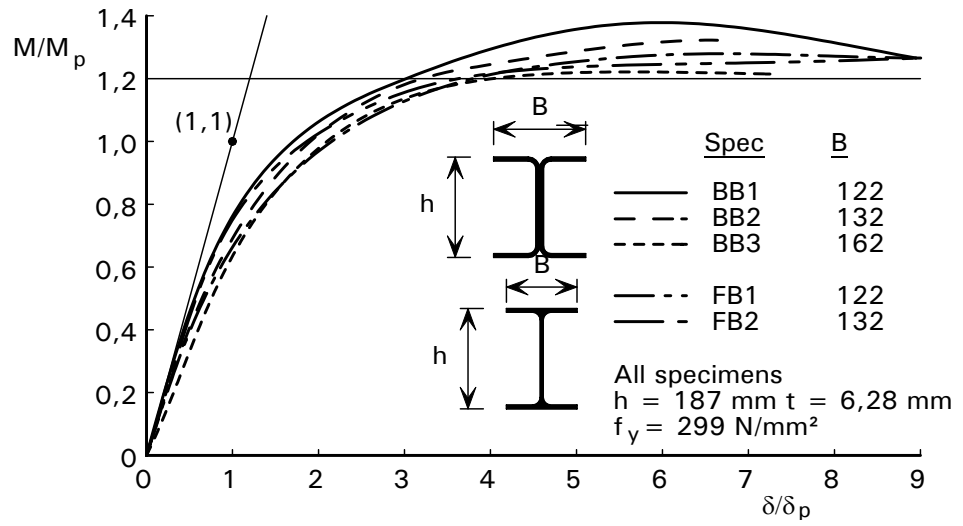

Figure C.4.10 Moment/deflection response of tested beams

C.5 MEMBER DESIGN

C.5.1 Introduction

No matter what the material of the member, a structural member essentially supports loads much in the same manner (e.g. by flexure or strut action). It is therefore perhaps a rather obvious statement that similar checks have to be carried out for stainless steel members as those for members in carbon steel. However, the designer should be aware of possible differences in design behaviour, such as second order effects or overall frame stability that are not covered in this Design Manual, but may be found in some carbon steel structural codes².

Elastic global analysis is recommended for establishing forces and moments in members. Although in principle plastic global analysis could be used, there are presently certain difficulties to be addressed in design. These difficulties are associated with the strain hardening properties of stainless steel and in particular the moment-rotation characteristic of a stainless steel beam likewise displaying hardening behaviour. In the formation of a plastic mechanism, plastic hinges are required to undergo various degrees of rotation. Thus, where strain hardening occurs, the moments at the hinges will be above the nominal plastic moment (plastic modulus multiplied by the 0,2% proof stress) by amounts depending on the degrees of rotation. Therefore the calculation of the distribution of moments around a frame would involve kinematic considerations. With further study, it may be possible to enable bounds to be put on the additional moments (above the nominal plastic moment) to circumvent these analytical difficulties. Connections would have to resist the enhanced moment. Alternatively, it may be possible to show that connections can provide the required rotation to realise the mechanism.

In considering instability caused by member buckling, reference is made to the tangent modulus approach. This approach is adopted by the American code for cold formed stainless steel²⁷. The approach is based on replacing Young's modulus (in carbon steel buckling provisions) by the tangent modulus E_t corresponding to the buckling stress in the stainless steel member. Since E_t varies with stress and the buckling stress is a function of E_t , the approach generally requires iterations to find the solution.

In some of the recommendations given in this Design Manual, an effective design curve was derived by the tangent modulus approach, the necessary iterations having already been carried out for the designer. The derivation can be best demonstrated by way of an example.

Suppose it is required to find the stainless steel curve corresponding to the Euler buckling curve for carbon steel columns. For carbon steel (and any linear elastic material), the limiting stress f_{lim} is given by:

$$f_{lim} = \pi^2 E \left(\frac{l}{i^2} \right)$$

Defining non-dimensional parameters:

$$\chi = \frac{f_{\text{lim}}}{f_y} \quad \text{and} \quad \bar{\lambda} = \frac{\ell/i}{\pi} \sqrt{\frac{f_y}{E}}$$

gives the limiting (Euler) curve, expressed as:

$$\chi = \frac{1}{\bar{\lambda}^2}$$

For stainless steel, E is replaced by the tangent modulus E_t :

$$f_{\text{lim}} = \pi^2 E_t \left(\frac{l}{i^2} \right)$$

Using the Ramberg-Osgood relationship for describing the stress-strain curve

$$\varepsilon = \frac{f}{E} + 0,002 \left(\frac{f}{f_y} \right)^n$$

the tangent modulus can be derived as

$$E_t = \frac{df}{d\varepsilon} = \left[\frac{1}{E} + \frac{0,002n}{f_y} \left(\frac{f}{f_y} \right)^{n-1} \right]^{-1}$$

and therefore

$$\frac{E_t}{E} = \left[1 + 0,002 \frac{nE}{f_y} \left(\frac{f}{f_y} \right)^{n-1} \right]^{-1}$$

But, at buckling $f = f_{\text{lim}}$, $(f_{\text{lim}}/f_y) = \chi$ and $\chi = \frac{1}{\bar{\lambda}^2} \left(\frac{E_t}{E} \right)$ so

$$\chi = \frac{1}{\bar{\lambda}^2} \left[1 + 0,002 \frac{nE}{f_y} \chi^{n-1} \right]^{-1}$$

In general, to solve $\chi = \text{function}(\bar{\lambda})$, an iterative approach is required since χ appears on both sides. However, on rearrangement:

$$\bar{\lambda} = \left[\chi + 0,002 \frac{nE}{f_y} \chi^n \right]^{-1/2}$$

From this equation, a family of curves can be generated for each value of n depending on the ratio of E/f_y . Some example curves are compared with the original Euler curve for carbon steel in Figure C.5.1. All the designer has to do now is to calculate $\bar{\lambda}$ using the initial modulus value (the modulus of elasticity within the limit of proportionality) and then find χ directly using the appropriate curve.

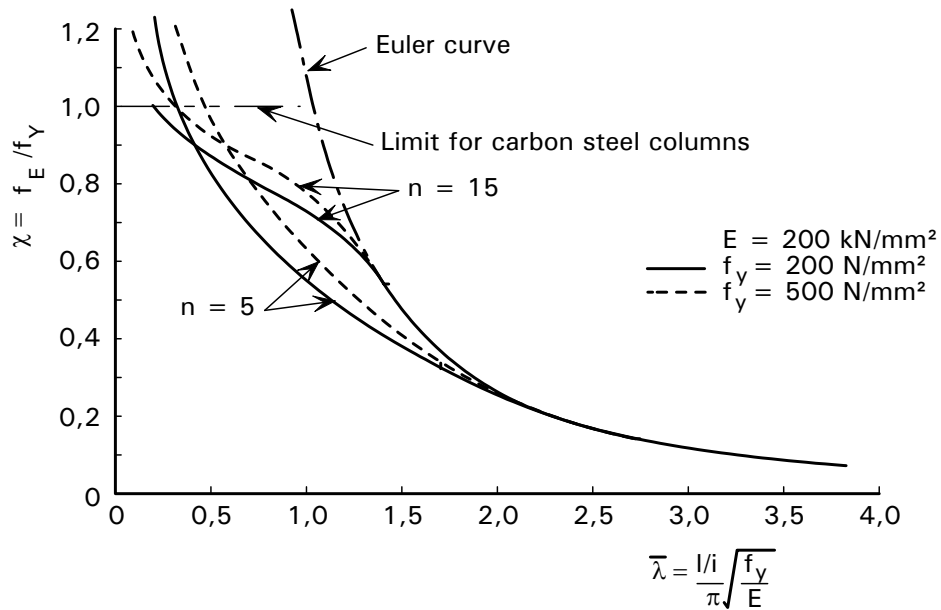

Figure C.5.1 *Effective 'design' curves for Euler column buckling in stainless steel*

As can be seen the curves with the lower n value, which implies a lower limit of proportionality, diverge from the carbon steel curve at lower stresses than do the curves associated with the higher n value. However, at stresses above $0,9 f_y$, the curves with low n value lie above those of high n ; this follows from the fact that the tangent modulus of the low n material is greater than that of the high n material in this stress range. It may be noted that a carbon steel stress/strain curve may be closely approximated by very high n values (say > 30), in which case the design curve departs from the Euler curve and becomes a horizontal plateau at $\chi = 1,0$.

Although the above technique has been occasionally used to derive effective design curves, greater credence has been attached to establishing the recommended curves with available experimental data. For instance, it is known that the Euler curve discussed above is a poor representation of the true strength of columns within the practical slenderness range because of the influence of factors including initial out-of straightness, eccentricity of loading and residual stresses.

The last paragraph in Section 5.1 states that the design recommendations should not be applied to members having cross-sections not possessing any axis of symmetry. Carbon steel codes are similarly restricted.

C.5.2 Tension members

In general, tension members and their connections should be detailed such that the applied load acts along the member's centroidal axis. This is not always possible and the eccentric load will induce bending, which should be allowed for by reference to 4.7.6.

However, in the case of angles, recommendations are given for simple design, ignoring the moments due to eccentricity, using a modified expression for the ultimate tensile resistance in Section 6.2.3.

C.5.3 Compression members

C.5.3.1 General

The various forms of buckling listed in the Recommendations are in common with those pertinent to carbon steel columns. Indeed, the behaviour of stainless steel columns and carbon steel columns can be expected to be broadly similar, differing only in quantitative aspects. It may be helpful to consider how the non-linear stress-strain curve of stainless steel affects the comparison between the buckling strengths of similar stainless steel and carbon steel columns and members in general. There are three distinct regions of slenderness:

(a) At high slendernesses, i.e. when the axial strength is low, stresses in the stainless steel member are sufficiently low so that they fall in the linear part of the stress-strain curve. In this range, little difference would be expected between the strengths of stainless and carbon steel members assuming similar levels of geometric and residual stress imperfections. The limiting slenderness beyond which similar behaviour can be expected depends on the limit of proportionality and hence the n factor in the Ramberg-Osgood representation of the stress-strain curve. This dependence can be seen in Figure C.5.1.

(b) At low slenderness, i.e. when columns attain or exceed the squash load (area \times proof strength), the benefits of strain hardening become apparent. For very low slenderness, materials with higher hardening rates, i.e. materials of low n factors, will give superior column strengths to materials having high n factors and in particular carbon steels.

(c) At intermediate slendernesses, i.e. when the average stress in the column lies between the limit of proportionality and the 0,2% proof strength, stainless steel is 'softer' than carbon steel. This leads to reduced column strengths compared to similar carbon steel columns.

C.5.3.2 Flexural buckling

The buckling resistance in the Recommendations is given as the product of a reduction factor (χ) and the stub column resistance ($\beta_A A_g f_y$) divided by the 'material' factor for buckling (γ_{M1}). The reduction χ depends on the non-dimensional column slenderness $\bar{\lambda}$ and the appropriate column curve selected according to the constants given in Table 5.1. The reduction factor is derived from the lower root of the following equation and is based on the work of Ayrton and Perry (1886) in the UK and others on the continent:

$$(p_y - p_c) (p_E - p_c) = \eta p_E p_c$$

in which:

$$p_y = \beta_A f_y$$

$$p_c = \chi p_y$$

$$p_E = \pi^2 E / (\ell / i)^2$$

η is an empirically defined imperfection coefficient, each buckling curve having its associated value.

The equation is based on column failure being attained when the maximum stress in the compression fibre reaches p_y and takes into account the amplification of secondary 'imperfection' moments by the axial load.

The reduction factor is given as a function of the non-dimensional slenderness $\bar{\lambda}$ which is proportional to the effective length ℓ of the column. The effective length of a column is the length of a pin-ended member, of the same cross-section, that has the same buckling resistance as the actual member under consideration. Note that the length of a compression member, and hence the effective length, may be different for the two planes of buckling. The effective length factor of a compression member is dependent upon the conditions of restraint afforded to the member at its restraints and theoretically may vary from 0,5 to infinity. In practical structures the variation is somewhat less, ranging from 0,7 to perhaps no more than about 5.

Six idealised cases are illustrated in Figure C.5.2. For rigid jointed frames the restraining influence of incoming beams may be taken into account by reference to, for example, ENV 1993-1-1: Annex E.

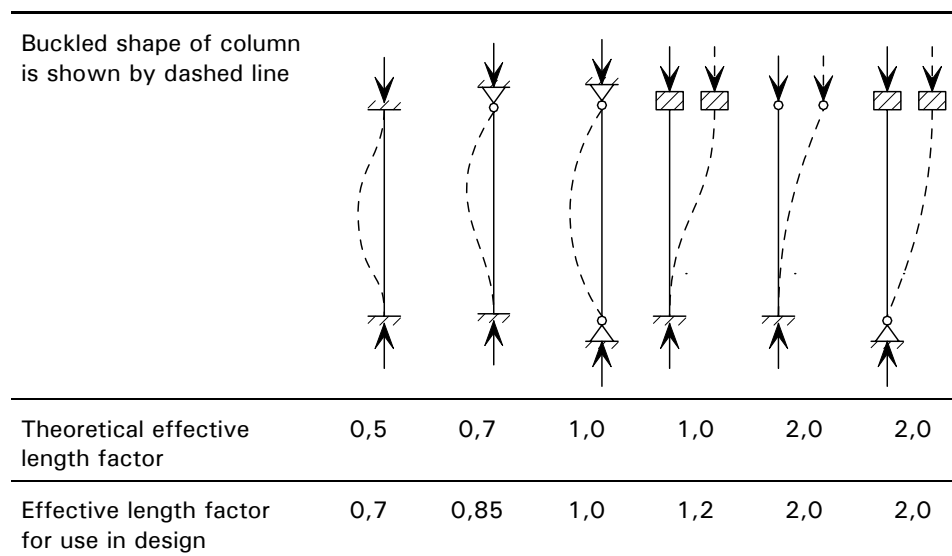

Figure C.5.2 *Effective length factors*

In some carbon steel codes², effective non dimensional slendernesses, $\bar{\lambda}_{\text{eff}}$, are given for angles in compression such that the effects of secondary moments, induced at the ends due to connection eccentricity, do not have to be explicitly considered. These expressions are empirical and cannot be verified for stainless steel angles, due to lack of data. Based on other evidence, it is likely that $\bar{\lambda}_{\text{eff}}$ would be slightly larger for stainless steel.

The constants α (imperfection coefficient) and $\bar{\lambda}_0$ (length of plateau region) in Table 5.1 were chosen after considering available data as follows.

Cold formed members ($\alpha = 0,49$, $\bar{\lambda}_0 = 0,40$)

*Hammer and Petersen*⁷⁸

This paper contains by far the largest single source of column test data for stainless steel. Over 200 specimens of annealed, $\frac{1}{4}$ hard, $\frac{1}{2}$ hard and fully hard type 1.4310 stainless steel were tested in slenderness ratios (ℓ/i) varying from 15 to 120. Specimens were prepared parallel and transversely to the rolling direction. Material thicknesses varied from 0,5 mm to 1,9 mm. All columns were built up from two cold formed hat sections spot welded to form a closed member. The section dimensions were designed so as to avoid local buckling of elements.

The non-dimensionalised results are plotted in Figure C.5.3. In the paper, no stub column proof loads are given; only the sheet proof strengths in the various tempers can be ascertained and these vary from 203 N/mm² (annealed condition) to 1571 N/mm² (fully hard condition, transverse direction). The close banding of the results confirms the adequacy of the non-dimensional variables. The apparent conservatism of the recommended design curve at intermediate slendernesses arises from the fact that sheet proof strengths, rather than stub column proof strengths, are used in the non-dimensional variables and hence strength enhancement in the cold worked corners of the specimens is ignored.

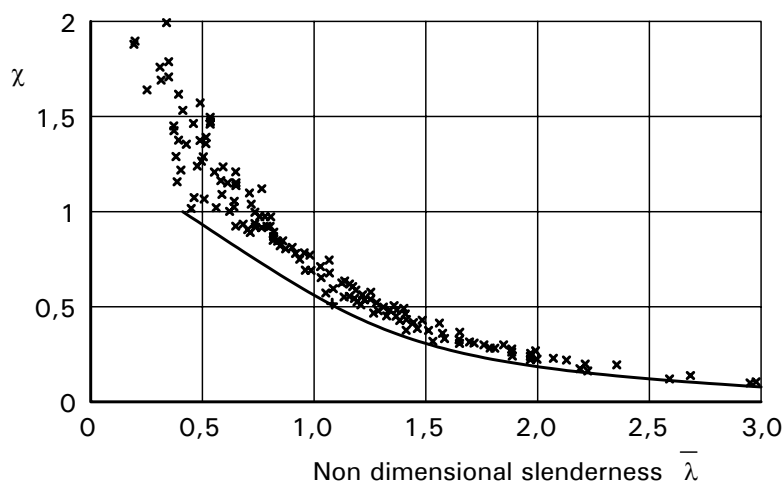

Euro Inox Design Manual, Eqns 5.3 and 5.4,
Cold formed sections: $\alpha = 0,49$, $\bar{\lambda}_0 = 0,40$

Figure C.5.3 Reduction factor versus non-dimensional slenderness for cold formed sections from grade 1.4310 material ⁷⁸

Johnson and Winter^{79,80}

A total of 15 column tests were carried out on type 1.4301 annealed stainless steel. The columns were built up using 1,5 mm thick cold formed channel sections. These were placed back to back to produce 11 I-sections and placed (nested) together to form 4 box sections. The two pieces were joined by means of a structural adhesive. The range of slenderness ratios (ℓ/i) tested was from 28 to 177. All sections were designed to be Class 2, i.e. to avoid local buckling.

The proof strength used in the non-dimensional quantities is based on the 'typical' stress-strain curve given in the references. The results of the column tests are shown in Figure C.5.4.

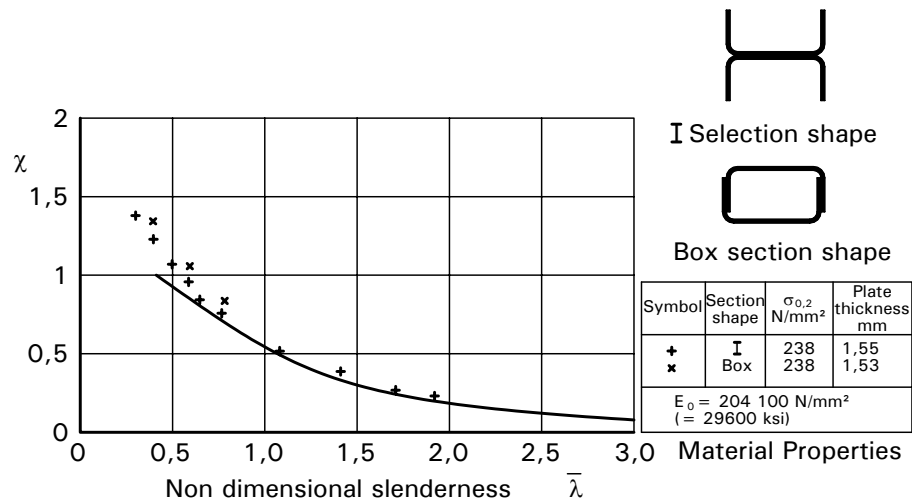

Euro Inox Design Manual, Eqns 5.3 and 5.4,
Cold formed sections: $\alpha = 0,49$, $\bar{\lambda}_0 = 0,40$

Figure C.5.4 Reduction factor versus non-dimensional slenderness for cold formed sections from 1.4301 material^{79,80}

Coetzee et al⁸¹

A total of 30 column tests were performed on three different grades of stainless steel. The materials under consideration were grades 1.4301, 1.4401 and the ferritic grade 1.4003. Ten lipped channel sections were produced from each material by a press braking process and cut into lengths which gave slenderness ratios (ℓ/i) ranging from 10 to 104. All materials used were approximately 2,5mm thick.

The results are given in Figure C.5.5.

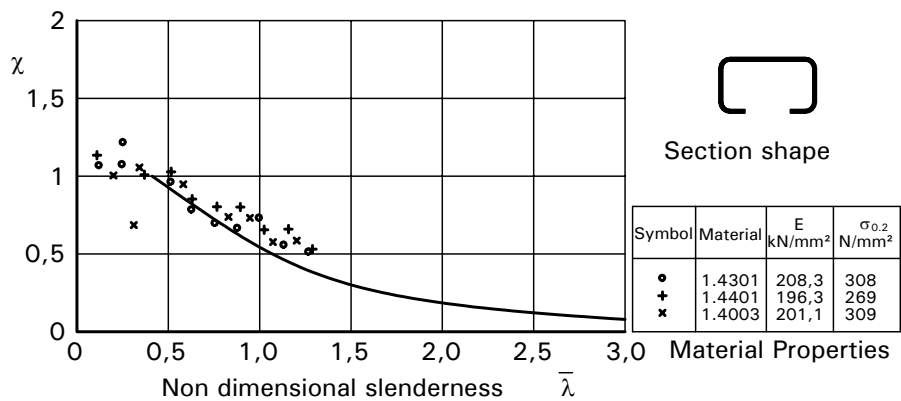

Euro Inox Design Manual, Eqns 5.3 and 5.4,
Cold formed sections: $\alpha = 0,49$, $\bar{\lambda}_0 = 0,40$

Figure C.5.5 Reduction factor versus non-dimensional slenderness for cold formed sections from grades 1.4301, 1.4401 and 1.4003 materials⁸¹

Cold formed and seam welded members ($\alpha = 0,49$, $\bar{\lambda}_0 = 0,40$)

Rasmussen and Hancock⁸²

A total of 18 hollow section columns in 1.4307 material were tested. The specimens consisted of 8 square hollow sections of 80 mm x 3 mm and 10

circular hollow sections of 101,6 mm x 2,85 mm, of various lengths. They were formed by cold rolling and subsequent seam welding. The specimens were paired with one specimen in each pair tested with a slight eccentricity of load to simulate a geometric imperfection. The results are shown in Figure C.5.6.

*Talja*⁷¹ and *Way*⁸³

Nine circular hollow sections of diameter 140 mm and thickness varying from 2 to 4 mm in grades 1.4541 (a stabilised version of grade 1.4301) and 1.4435 (a slightly higher alloyed version of 1.4404) were tested. The test results are also shown on Figure C.5.6. The 4 circular hollow sections of 140 mm x 2 mm in grade 1.4435 were classified as class 4 cross-sections and as there is no guidance on the calculation of the effective cross-sectional area for Class 4 CHS, the results were not plotted. All sections were loaded concentrically in compression.

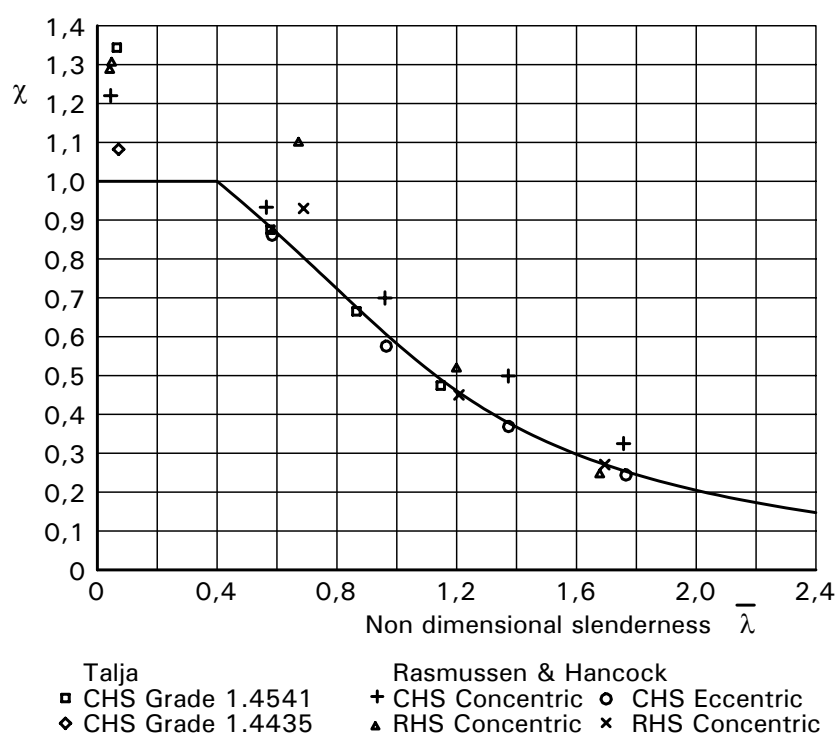

Euro Inox Design Manual, Eqns 5.3 and 5.4,
Cold formed and seam welded sections: $\alpha = 0,49$, $\bar{\lambda}_0 = 0,40$

Figure C.5.6 Reduction factor versus non-dimensional slenderness for hollow section columns

Members fabricated by welding ($\alpha = 0,76$, $\bar{\lambda}_0 = 0,20$ minor axis,
 $\alpha = 0,49$, $\bar{\lambda}_0 = 0,20$ major axis)

*van den Berg et al*⁸⁴

A total of 13 column tests were carried out on I section columns fabricated from type 1.4003 material. The columns buckled about the minor axis. Seven columns were nominally sized 140 x 70 mm and the remaining six were sized 180 x 90 mm. Both section sizes used different plate thicknesses for web and flange. Column slendernesses (ℓ/i) varied from 24 to 230.

It should be noted that the section sizes used in the column tests were not categorically stated anywhere in the paper. The sizes quoted above were inferred from the predicted failure loads given and the geometrical properties of the sections used. The results are shown in Figure C.5.7.

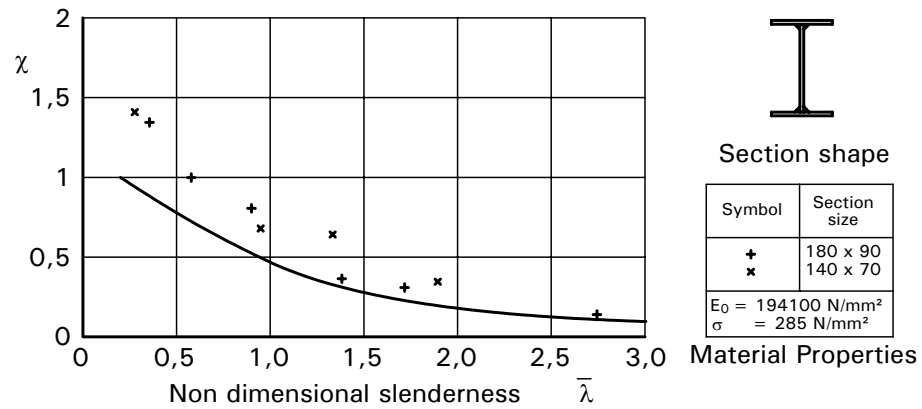

Euro Inox Design Manual, Eqns 5.3 and 5.4,
Welded sections, minor axis buckling: $\alpha = 0,76$, $\bar{\lambda}_0 = 0,20$

Figure C.5.7 Reduction factor versus non-dimensional slenderness for welded columns from grade 1.4003 material⁸⁴

*Steel Construction Institute*⁷⁷

Three welded columns in 6,28 mm thick 1.4404 material, having the same cross-section but different lengths, were designed and tested to provide information for the First Edition of the Design Manual. All cross-sections were of 187 mm overall depth x 132 mm flange width. The columns buckled about the minor axis. The measured 0,2% compressive proof strength was 299 N/mm². The results are shown in Figure C.5.8.

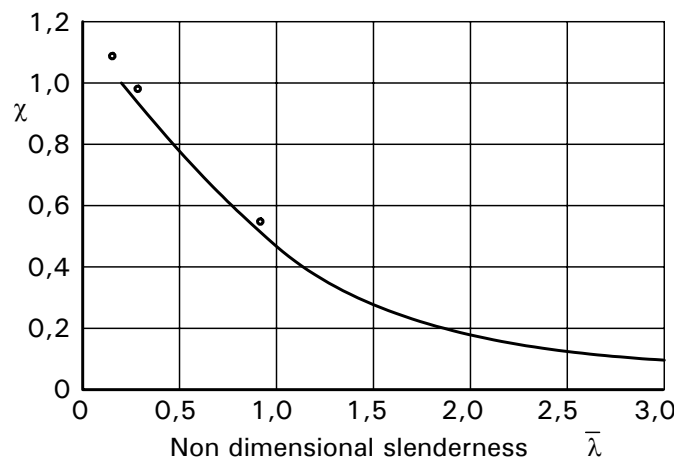

Euro Inox Design Manual, Eqns 5.3 and 5.4,
Welded sections, minor axis buckling: $\alpha = 0,76$, $\bar{\lambda}_0 = 0,20$

Figure C.5.8 Reduction factor versus non-dimensional slenderness for welded columns in grade 1.4404 material⁷⁷

The curve recommended for welded stainless steel columns buckling about the minor axis ($\alpha = 0,76$) is somewhat below the curve in ENV 1993-1-1 for similar carbon steel cold formed columns. The welded stainless steel columns were measured as being reasonably straight and it may be inferred that the reduced strengths were due to the presence of the severe residual welding

stresses to be expected in austenitic stainless steel welds (see Section 10.4.4 in the Recommendations). It is to be noted that the ferritic stainless steel columns in Figure C.5.7, in which residual stresses would have been closer to those found in carbon steel columns, did not suffer the same degree of reduction in capacity. Furthermore, it may be conjectured that duplex 1.4462 columns would perform similarly to ferritic steel. However, in the absence of data, it is recommended to use the $\alpha = 0,76$ curve for minor axis buckling, even for duplex 1.4462 welded columns. Finally, it is also possible that the 0,76 curve is too conservative for hot produced products as, again, residual stresses would not be expected to be as severe as those in welded columns.

Talja⁷¹ and Stangenberg⁸⁵

Recent tests were carried out on welded I section columns fabricated from grades 1.4301 and 1.4462. Three sections of 160 x 80 mm and 3 sections of 160 x 160 mm in 1.4301 material and 3 sections of 160 x 160 mm in grade 1.4462 were tested for buckling about the major axis. The results are shown in Figure C.5.9. In addition, three welded I sections of 160 x 80 mm and 3 of 160 x 160 mm in grade 1.4301 were tested for buckling about the minor axis (Figure C.5.10). In all cases, the sections were loaded in concentric compression.

The tests were modelled using a finite element analysis program and good agreement was obtained between the numerical model and test results. A parametric study looked at a wider range of slendernesses than that tested. The results of this numerical study are also shown on the Figures. The results of the tests and numerical analysis indicate that for major axis buckling, a more favourable buckling curve, $\alpha=0,49$ can be used.

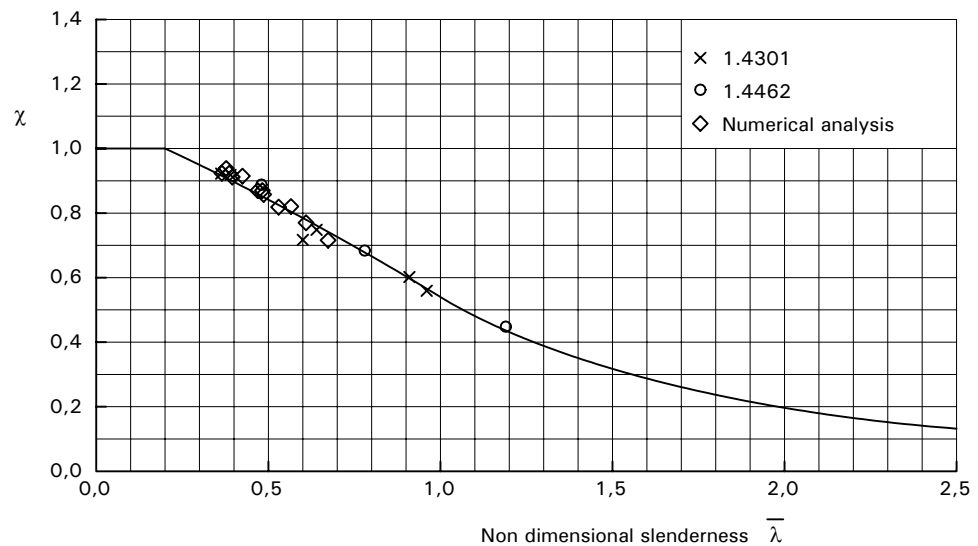

Euro Inox Design Manual, Eqns 5.3 and 5.4,
Welded sections, major axis buckling: $\alpha = 0,49$, $\bar{\lambda}_0 = 0,20$

Figure C.5.9 *Reduction factor versus non-dimensional slenderness for welded columns buckling about the major axis*

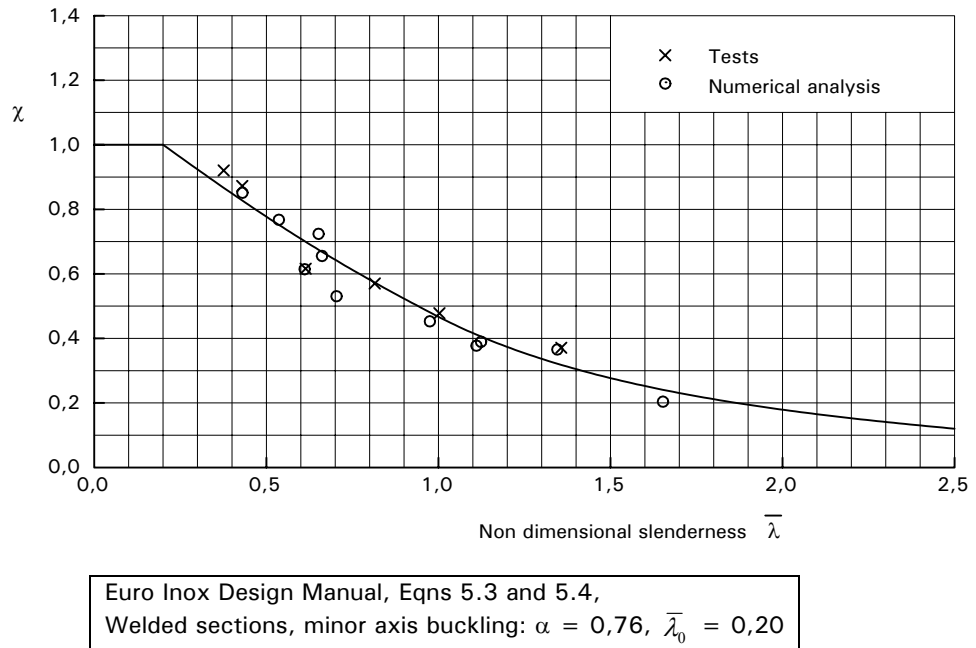

Figure C.5.10 *Reduction factor versus non-dimensional slenderness for welded columns buckling about the minor axis*

C.5.3.3 Torsional and torsional-flexural buckling

The torsional and torsional-flexural buckling modes are treated in a very similar manner to the flexural buckling mode in 5.3.3. That is, the elastic critical stresses pertaining to these modes are used instead of the flexural critical stress (the Euler stress) in the Perry-type column analysis.

The column curve selected ($\alpha = 0,34$ and $\bar{\lambda}_0 = 0,2$) for these modes is the same as that given for carbon steel columns in ENV 1993-1-3. This recommendation is based on an assessment of the test data reported in References 86 and 87. These data were obtained from tests on cold formed hat sections produced from four different types of stainless steel and a carbon steel. Up to three sizes of hat sections were used with any one material. The results are presented in Figure C.5.11 in terms of the reduction factor χ and torsional-flexural slenderness $\bar{\lambda}_{TF}$, the stub-column proof strengths being used in all calculations.

It should be noted that $\bar{\lambda}_{TF}$ is a function of the effective length for twisting which, for the tests, is difficult to be precise about, due to the nature of the supports used - a ball bearing at each end. It was assumed that the axial load would provide sufficient friction at the bearings to prevent twisting at the ends of each column and thus an effective length factor for twisting of 0,7 (see C.5.4.2) was taken. It should be noted that different assumptions for the effective length for twisting would displace the data points either to the left or right of their positions in Figure C.5.11. Thus the design line and the data points should not be regarded as being fixed relative to each other. However, the above assumption is considered to be probably conservative but, more importantly, the inclusion of carbon steel columns and their ensuing results gives confidence that stainless steel columns are at least equal in strength to carbon steel columns for torsional-flexural failure.

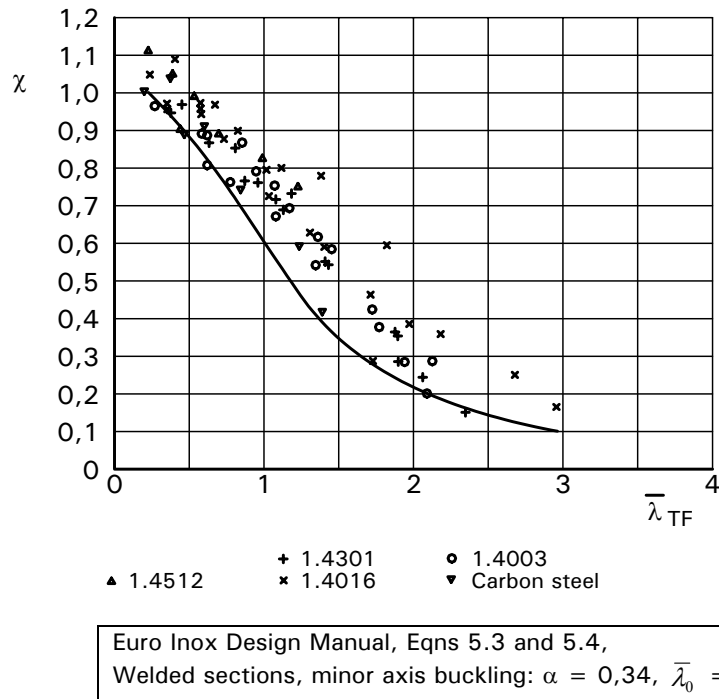

Figure C.5.11 *Reduction factor versus non-dimensional slenderness for torsional-flexural buckling*

C.5.4 Flexural members

C.5.4.1 General

Again, checks for establishing the resistance of a stainless steel beam are similar to those carried out for carbon steel beams.

With respect to overall member buckling (i.e. lateral-torsional buckling), the general comments given in C.5.3.1 also apply here.

C.5.4.2 Lateral-torsional buckling

When the compression flange of a beam is not fully restrained, it has a tendency to buckle sideways. The tension flange, on the other hand, tries to remain straight, with the net effect that the beam twists about its longitudinal axis as the beam buckles laterally. Restraints may be considered to be effective against lateral-torsional buckling if they provide either resistance to lateral movement or prevent twisting of the section. No guidance is given in the Recommendations as to what constitutes an adequate restraint but there is no reason why rules developed for carbon steel beams should not suffice, e.g. lateral restraints should be capable of sustaining a nominal force of 2½% of the compression flange force and should be connected to a stiff part of the structure.

Note that lateral-torsional buckling is not a possibility when bending is about the minor axis; in this case flexural buckling always governs.

For an idealised perfectly straight elastic beam, there are no out-of-plane deformations until the applied moment reaches the critical moment M_{cr} when the beam buckles by deflecting laterally and twisting. The failure of an initially straight slender beam is initiated when the additional stress induced by elastic buckling reaches yield. An initially straight beam of intermediate slenderness may yield before the critical load is reached, because of the combined effects of in-plane bending stresses and residual stresses, and may subsequently buckle inelastically. For very stocky beams, the inelastic buckling load may be higher

than the in-plane plastic collapse load and the resistance moment of the beam is not affected by lateral-torsional buckling. Real beams differ from the idealised beams in much the same way as real compression members differ from idealised struts. Following the approach adopted for column design, beam design to 5.4.2 is based on an empirical adaptation of the Perry formula.

In a strut, the compression is generally constant throughout its length, but in a beam the bending moment and therefore the force in the compression flange usually varies along its length. The variation of the flange compression along the beam affects the buckling load of the member. This is taken account when calculating the slenderness λ_{LT} in Appendix B. Likewise the effect of various restraint conditions and whether the load is destabilising or not are also accounted for in the calculation of λ_{LT} .

Tests by van Wyk et al⁸⁸ involved beams in three materials (types 1.4301, 1.4016 and 1.4003) of lengths ranging from 300 mm to 1600 mm under three point bending. The same cross-section was used in all tests and comprised two cold formed 50 mm x 15 mm channels joined back-to-back. The load was applied above the top flange and could move with the beam as it buckled, i.e. it was a destabilising load. The results are shown in Figure C.5.12. Note that the ordinate is a reduction factor applied to the plastic moment of resistance.

The other data available at the time of preparing the First Edition was Japanese data⁸⁹ for short welded I beams. Discounting those beams which failed prematurely by local flange buckling, the Japanese data fall around $\bar{\lambda}_{LT} = 0,18$ in Figure C.5.12. There were no other data available at the time the First Edition was written relating to lateral-torsional buckling of welded stainless steel beams.

The design line proposed in the First Edition for cold formed sections was based on an imperfection coefficient of $\alpha = 0,34$ and a limiting slenderness $\bar{\lambda}_{0,LT} = 0,2$ (as compared to $\alpha = 0,21$ and $\bar{\lambda}_{0,LT} = 0,2$ for cold formed carbon steel members in ENV 1993-1-1). However, carbon steel data suggested that the plateau region is much longer and in ENV 1993-1-1 no allowance needs to be made for lateral torsional buckling when $\bar{\lambda}_{LT} \leq 0,4$. A vertical step is thus introduced into the design curve. For stainless steel there were insufficient data to support this and a more conservative requirement that no allowance needed to be made for lateral torsional buckling when $\bar{\lambda}_{LT} \leq 0,3$ was introduced, again leading to a vertical step in the design curve.

Since the buckling curve recommended for stainless steel cold formed sections ($\alpha = 0,34$) was the next lower curve to that for carbon steel cold formed sections ($\alpha = 0,21$), it was suggested that $\alpha = 0,76$ may be suitable for welded stainless steel sections (compared to $\alpha = 0,49$ for welded carbon steel sections).

The Japanese data verified that no allowance needed to be made for lateral torsional buckling when $\bar{\lambda}_{LT} \leq 0,3$ for welded beams and hence also was conservative for cold formed beams.

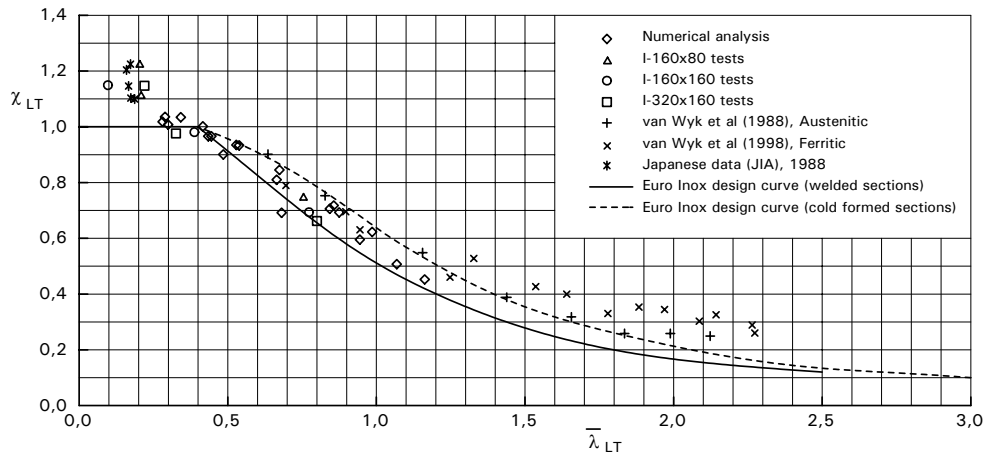

Euro Inox Design Manual, Eqns 5.12 and 5.13,
 Cold formed sections: $\alpha = 0,34$, $\bar{\lambda}_0 = 0,40$
 Welded sections: $\alpha = 0,76$, $\bar{\lambda}_0 = 0,40$

Figure C.5.12 Reduction factor versus non-dimensional slenderness for lateral torsional buckling

For the Second Edition of the Design Manual, tests were carried out on three different sized welded I sections^{71,85}. Three sections of 160 x 80 mm, 3 of 160 x 160 mm and 3 of 320 x 160 mm in 1.4301 material were tested. Also 3 welded I sections of 160 x 160 mm in grade 1.4462 were tested. These beams were tested in four-point bending. The levels under the force were free to move in the horizontal plane. There was also free rotation about the vertical axis, free movement in the horizontal plane and sideways translation. The results are plotted also in Figure C.5.12. These tests were modelled using a finite element analysis program and good agreement was obtained between the predicted results and test results. A parametric study looked at a wider range of slendernesses. The results of this study are also shown on the Figure.

The results of the tests and numerical analysis indicate that it is safe to increase the limiting slenderness, $\bar{\lambda}_{0,LT}$ to 0,4 and increase the limit on $\bar{\lambda}_{LT}$ above which it is necessary to allow for lateral torsional buckling from 0,3 to 0,4. The vertical step in the design curve in the First Edition is thus removed.

C.5.4.3 Shear resistance

The general approach for establishing the shear resistance of webs is based on the simple post-critical method of ENV 1993-1-1. In comparison to the alternative tension field method, the simple post-critical method is more widely applicable (the tension field method is restricted for web panel aspect ratios a/d between an absolute lower limit of 1,0 and an economic upper limit of 3,0) and is simpler in application.

In common with other forms of plate buckling, slender plates under shear are able to reach ultimate strengths higher than the elastic critical stress values. The method takes advantage of this in the design line for carbon steel. This enhancement is also to be expected for slender stainless steel webs, as the stresses are low (see C.5.3.1). However, where web slendernesses are such that the elastic critical stress is approximately equal to the yield stress (at $\bar{\lambda}_w = 1,0$), a relatively large reduction in strength occurs.

There are few data on the shear behaviour of stainless steel webs. Whilst it is true that a number of tests have been conducted on beams, these have been to

examine flange behaviour; flange failure prevented the development of high shears in the webs.

Carvalho et al⁹⁰ tested short span cold formed beams of varying depths in three materials (stainless steel grades 1.4301, 1.4016 and 1.4003). Each half of the beams was of square aspect ratio. When the First Edition of the Design Manual was prepared, these were the only shear buckling test data available and consequently a design curve was derived which gave a satisfactory lower bound to the experimental data. The design curve was subsequently adopted in ENV 1993-1-4. Since then, the validity of these data has been questioned. For example, the short member lengths led to results which were difficult to analyse correctly because the basic kinematic assumption by Bernoulli was less accurate. The method chosen to transfer the load into the webs also led to difficulties in analysing the results. In addition, the test specimens were cold formed profiles with internal radii which gave less favourable conditions for a tension field to develop, compared to an I-section.

A later test programme by Olsson⁹¹ included 8 tests on welded I-sections. Four different cross-sections and two different stainless steel grades (1.4301 and 1.4462) were considered. The beams were doubly symmetric, with the same flange dimensions and the same web height. The web slenderness h_w/t_w varied between 37,5 and 200, and the web aspect ratio varied between 2 and 3. The test results showed that the existing design procedure was very conservative. The tests were modelled using a finite element program and good agreement was achieved between the predicted results and test results. A subsequent parametric study analysed the shear buckling resistance in a wider range of I-section beams than was tested.

A new design procedure was developed which did not take into account the work carried out by Carvalho et al. The new procedure is closely based on the procedure in ENV 1993-1-5⁵⁰. Figure C.5.13 shows the test results and design curves in ENV 1993-1-5 (for carbon steel), the previous conservative approach included in ENV 1993-1-4 and the new design curve in this Second Edition.

Real has also carried out an experimental and numerical investigation to study the response of stainless steel plated girders subjected to shear load⁹². A method for predicting the shear resistance of stainless steel beams based on the tension field method in ENV 1993-1-1 is proposed by Real, including new design expressions to determine the initial shear buckling stress.

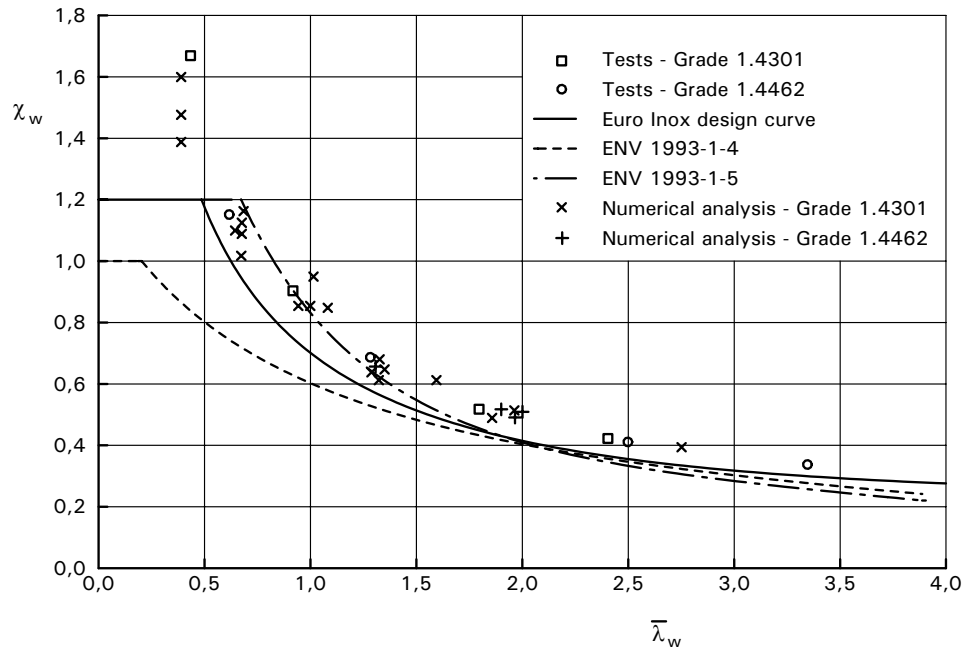

Figure C.5.13 Reduction factor versus non-dimensional slenderness for shear buckling of webs

C.5.4.4 Web crushing and crippling

When the First Edition of this Design Manual was written, there were no relevant test data on stainless steel webs, and so the use of guidance for carbon steel was recommended. Since then, a test programme was carried out to measure the web crushing and crippling resistance of stainless steel plate girders⁹³. Nine grade 1.4301 welded I-section beams were subjected to concentrated point loads. On five of the beams, the load was applied far from the girder end (patch loading) and on the remaining four beams the load was applied near an unstiffened end (end patch loading).

For the patch loading, the beams were doubly symmetric, with h_w/t_w varying from 50 to 110 and the lengths of the beams varying from 996 mm to 1682 mm. Both ends of the beams were stiffened with vertical steel plates. Loading plates of width 40 mm and 80 mm were used. The load was applied at the midspan of the simply supported beam, on the upper flange, centrally over the web.

For the end patch loading, the beams were doubly symmetric with h_w/t_w varying from 50 and 80 and the lengths of the beams varying from 996 mm to 1682 mm. The width of the loading plates varied from 20 mm to 60 mm. One end of the beam was stiffened with a vertical steel plate and the load applied at varying distances from the unstiffened beam end.

The patch load tests were modelled using a finite element analysis program and good agreement with the test results was obtained. A parametric study was carried out to study the behaviour of a wider range of web slendernesses.

The test and numerical results were analysed and comparisons made with the guidance given in ENV 1993-1-1², ENV 1993-1-1 Annex J and ENV 1993-1-5⁵⁰. (The existing guidance given in ENV 1993-1-4 refers simply to ENV 1993-1-1.) The results indicated that the design procedure given in ENV 1993-1-5 gives the best agreement between test and predicted values for both patch loading and end patch loading. In this model the characteristic resistance, F_r is a function of the yield resistance F_y , the elastic buckling load, F_{cr} and a

resistance function $\chi(\lambda)$. Figure C.5.14 shows the results of the tests, numerical analyses and the design curve.

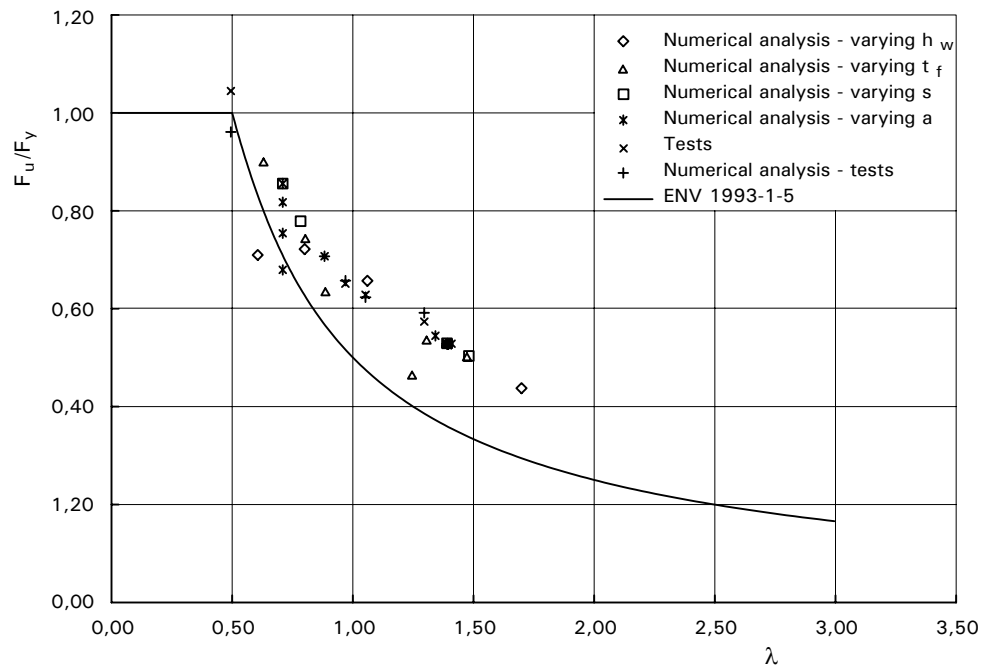

Figure C.5.14 *Web crippling of stainless steel beams – test data and design curve*

C.5.4.5 Transverse stiffeners

In essence, transverse stiffeners are to be treated as compression members requiring a check on cross-sectional resistance (bearing check) and buckling resistance. For intermediate stiffeners not subject to external loads, the axial loads are fed in gradually via shear in the web and the bearing check can be dispensed with.

The effective cross-section of the stiffener includes a proportion of web plate of up to $11\epsilon t_w$ on either side of the stiffener flat. This effective width of web plate corresponds to the Class 3 limiting width for outstands in Table 4.2 of the Recommendations, i.e. the portion of web plate that can develop its proof load.

The buckling check is to be carried according to 5.3.3 or 5.5.2 depending on whether symmetric stiffeners or asymmetric stiffeners are used. In the latter case an eccentricity moment of $M = N_s e$ has to be allowed for, where N_s is the axial force in the stiffener and e is the distance of the centroid of the effective stiffener section from the mid thickness of the web.

The expression given for the force in an intermediate stiffener with no external loading is taken from ENV 1993-1-5⁵⁰.

The requirements given for the minimum second moment of area are to ensure that the stiffeners are sufficiently rigid to prevent web buckling. They are the same empirical expressions as those used in ENV 1993-1-1 and other steel codes.

C.5.4.6 Determination of deflections

The accurate calculation of the deflections of members composed of stainless steel materials is a complex matter. The shape of the load-deflection curve is affected by the non-linear material stress-strain relationship⁹⁴ and may be

influenced by local buckling effects in the compression flange. Whereas in the case of carbon steel members the modulus is constant (i.e. equal to Young's modulus) down the beam depth and along the length of the beam, for stainless steel members the (tangent) modulus may vary throughout the beam according to the value of stress at each point. An accurate deflection calculation will generally require the use of iterative techniques and this is unsuitable for design.

In the Recommendations an approximate method is given. It uses the secant moduli (see Figure C.5.15) corresponding to the stresses in the extreme fibres as a basis for estimating deflections. This approach has been shown⁸⁰ to give adequate deflection estimates for design purposes. It should be borne in mind that deflection calculations can only provide estimates of the actual deflection that will occur in practice. Uncertainties in member restraint, element thicknesses, material behaviour (Appendix C), let alone the loading, imply that it is unreasonable to expect or seek mathematical exactitude in estimating deflections.

Calculating deflections by using a unique value of the secant modulus appropriate for the most highly stressed cross-section in the member leads to an over-estimation of deflections. The magnitude of the over-estimation depends on the distribution of the bending moment along the member; for example, the error is less significant for a beam with a uniform bending moment. A new methodology for calculating deflections in stainless steel beams, which takes fully into account the material non-linearity, has been proposed by Real⁹². It is based on an analytical expression for the moment-curvature relationship for stainless steel cross-sections. A new expression for an equivalent elastic modulus, which represents the general behaviour of the beam, is defined. The procedure involves integration along the length of the member. This method has been shown to give more accurate predictions of the deflections in stainless steel beams than the simple method given in the Recommendations.

It should be noted that beams may suffer some permanent deflection on removal of the load; this will be approximately $(1 - E_s/E)$ times the estimated total deflection (see Figure C.5.15).

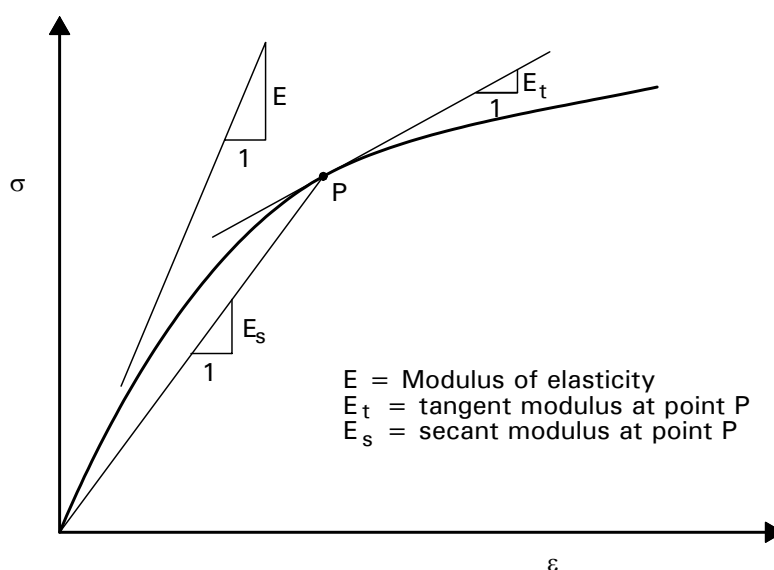

Figure C.5.15 *Young's tangent and secant moduli*

C.5.5 Members subject to combinations of axial loads and bending moments

C.5.5.1 Axial tension and bending

The provisions given in the Recommendations are taken from Reference 95, which is closely based on the UK structural design code, BS 5950-1⁴⁵.

C.5.5.2 Axial compression and bending

The formulae given in the Recommendations for combined compression and bending are derived from the interaction formulae given in ENV 1993-1-1. The constant '1,5' appearing in the formulae in the Recommendations is conservative; in ENV 1993-1-1 this is replaced by complex functions dependent on the slenderness of the member.

A major difference between the recommended formulae and the ENV 1993-1-1 formulae, is that the former have been separated according to the type of loading and the ensuing potential modes of buckling. This permits a greater level of understanding and, it is believed, simplifies their application.

For the Second Edition, six beam column tests were carried out on welded I-sections in grade 1.4301 stainless steel^{71,85}. Three of the tests were numerically modelled and satisfactory agreement with the test results was obtained. In addition, eight pin-ended CHS columns were tested, with an axial load applied eccentrically through the centre of the wall thickness^{71,83}.

Both sets of test results were compared against the results predicted by the expressions in the existing Recommendations, and it was concluded that the design method predicted results with a satisfactory margin of safety^{85,83}.

Biaxial bending

Again, the recommended formulae are simplifications of those in ENV 1993-1-1.

C.6 JOINT DESIGN

C.6.1 General recommendations

C.6.1.1 Durability

The designer should consider ways of preventing corrosion at all stages of connection design.

Corrosion problems are most likely to occur at connections, whether they are bolted or welded connections. This is due to a number of potential deleterious features at connections such as crevices, dissimilar metal contact, heat affected zones, etc. As always, corrosion only occurs if there is a source of moisture. Sections 3.6 and 10.4 contain further information.

C.6.1.2 Design assumptions

The general recommendations given here are no different from those for carbon steel. Connections work, even where the assumed path is not actually realised, because of steel's great ductility and hence the potential for stress redistribution. In this respect, stainless steel, and particularly austenitic grade, is superior to carbon steel. Nevertheless, the deformation capacity of the fastening elements should be considered; it is not generally safe to share the load in a connection between different types of fasteners. For example, in a hybrid connection, fillet welds could fail before bolts in shear have taken up the clearances in the bolt holes.

C.6.1.3 Intersection and splices

Reducing bending moments at intersections and splices by avoiding eccentricities reflects good engineering practice.

At mid-height, the extreme fibres of a column are fully stressed (to f_y) at the ultimate limit state, even for a slender column (the reduction in strength due to column slenderness is matched by the stress due to the moment arising from strut action). Thus, any splice at mid-height has to be designed for forces and moments corresponding to the full design resistance.

C.6.1.4 Other general considerations

Although standardised details can be advantageous for carbon steelwork, the greater material cost of stainless steel favours a move away from uniformity of details to reduce such costs, even if increased labour charges result.

Again, the designer should be aware of the requirements of fabrication as given in Section 10. Control of welding distortion in particular should be noted, see Section 10.4.

C.6.2 Bolted connections

C.6.2.1 General

A variety of stainless steel fasteners is available, including bolts, rivets and self-tapping screws. The recommendations apply to bolts or set screws with washers under both the bolt head and the nut. Because of the soft surface of annealed austenitic stainless steel grades, hardened washers may be necessary to prevent any tendency to dig into the plate surface.

Stainless steel members will be connected to each other with bolted connections having similar geometric forms to those used in carbon steel structures. This being so, and with the expected broad similarity between stainless steel and carbon steel connection behaviour, the recommendations have been developed by verifying through testing the existing rules for carbon steel as set out in ENV 1993-1-1². It has been found necessary to modify the estimation of net area (see commentary to 4.6), and the design of lap joints with bolts in a single line lying transversely to the direction of stress. New provisions are introduced to limit bearing deformations. Additionally, the simplification of basing bearing resistance on the bolt diameter rather than hole diameter has been introduced.

C.6.2.2 Preloaded bolts

In carbon steel structures subject to vibration, high strength friction grip bolted connections are a viable option. The requirement that testing be carried out to prove the acceptability of stainless steel connections designed as slip resistant arises from the following concerns:

- Variable torque characteristics of stainless steel bolts.
- Stress relaxation in stainless steel bolts.
- Low coefficients of friction for stainless steel.
- The possibility of fretting corrosion.

Note also that welding the nut to the bolt to prevent the former from unscrewing is a practice to be avoided.

C.6.2.3 Connected parts

Holes

The standard hole sizes are in common with carbon steel values. For holes with greater clearances or for slotted holes, there are no data yet available for stainless steel and specific testing would have to be carried out.

Position of holes

The minimum criteria for pitch, end and edge distance are given for the following reasons:

- To give sufficient clearance for tightening bolts.
- To limit any adverse interaction between high bearing stresses on neighbouring bolts.
- To eliminate any tendency for bursting or in-plane deformation during drilling or punching; this reason particularly relates to minimum edge distance criteria.
- To provide adequate resistance to tear-out of the bolts.

These reasons are common to carbon steelwork⁹⁶.

Maximum criteria are set for carbon steelwork to eliminate local buckling of the plies and to ensure that a continuous paint film is maintained across the plies, thus preventing corrosion at the interface. For stainless steel, the latter reason does not really apply and therefore the criteria in the Design Manual may be relaxed.

In this Second Edition of the Design Manual, the position of holes is expressed in terms of the bolt hole diameter, d_0 rather than the bolt diameter, d , in accordance with ENV 1993-1-1.

Bearing resistance

The great ductility of stainless steel permits a greater degree of redistribution of forces between fasteners than is the case with carbon steel. This allows the resistance of a connection to be assessed by summing the individual resistances at each bolt instead of taking the lowest resistance and multiplying it by the number of bolts. Nevertheless, care needs to be exercised, as failure by bolt shearing, in which the deformation is low compared to other failure modes, would limit the degree of redistribution possible.

The various failure modes that need to be considered for a bolted connection are illustrated in Figure C.6.1. These apply equally to connections in stainless steel or carbon steel.

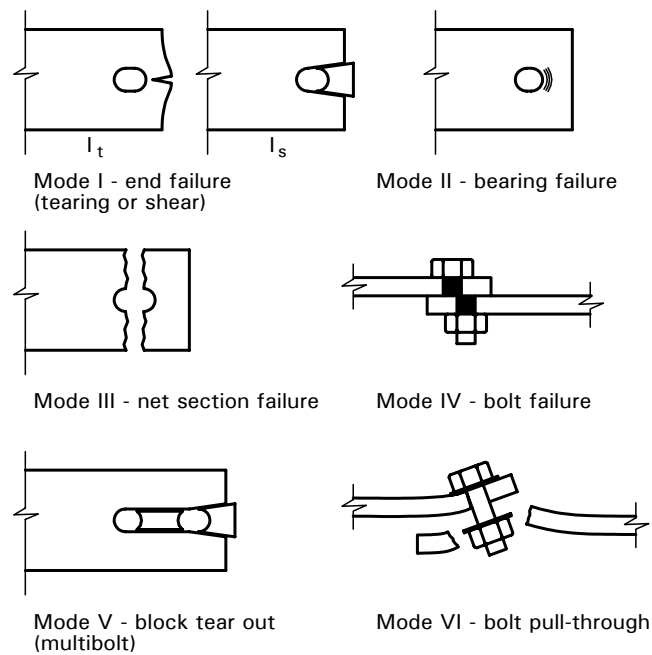

Figure C.6.1 Bolted connection failure modes

Excluding failure mode types III and IV (which are dealt with in Section 6.2.3 *Tension resistance* and 6.2.4 respectively), the bearing resistance is related to the α factor, which is given as follows:

mode I: $\alpha = e_1/3d$

mode II: $\alpha = 1,0$

mode V: $\alpha = p_1/3d - 1/4$

mode VI: $\alpha = 0,6$

The suitability of these factors is verified for stainless steel bolted connections by reference to the following data:

*Tests conducted for the First Edition of the Design Manual*⁹⁷

Some thirty-one bolted connection specimens were designed to fail in variety of modes, as shown in Table C.6.1. Specimens 1 to 25 were single bolt; specimens 26 to 31 had two or three bolts. Since the connected plies were under test, rather than the bolt, all bolts were of carbon steel up to grade 12.9.

Table C.6.1 Summary of bolted connection tests⁹⁷

Specimen No	Steel grade	Nominal dimensions (mm)			$\frac{e_1}{d}$	Failure mode ¹⁾		α_{exp} (0,4 F _{max bearing} /f _u)	$\alpha_{exp}/\alpha_{predicted}$		Comments
		W	t	d		Predicted	Actual		Predicted mode	Actual mode	
1	1.4307	90	2	12	1,5	I	I _t	0,73	1,43	1,43	Spec 3 scrapped
2	1.4307	90	2	12	2,5	VI (I)	VI	1,09	1,81	1,81	
3	1.4307	90	2	12	3,5	VI (II)					
4	1.4307	90	2	12	4,5	VI (III)	VI	0,98	1,63	1,63	
5	1.4307	40	2	12	4,5	VI (III)	VI	0,89	1,48	1,48	
6	1.4307	40	2	12	4,5	VI (III)	III	0,88	1,46	1,02	
7	1.4404	90	2	12	1,5	I	I	0,76	1,46	1,46	
8	1.4404	90	2	12	2,5	VI (I)	VI	1,17	1,95	1,95	
9	1.4404	90	2	12	3,5	VI (II)	VI	1,06	1,76	1,76	
10	1.4404	90	2	12	4,5	VI (II)	VI	1,16	1,94	1,94	
11	1.4404	40	2	12	4,5	VI (III)	III	0,88	1,47	1,03	
12	1.4404	40	2	12	4,5	VI (III)	III	0,91	1,52	1,07	
13	1.4404	100	6,3	20	1,5	I	I _t	0,69	1,38	1,38	
14	1.4404	100	6,3	24	3,5	VI (II)	VI	0,72	1,19	1,19	
15	1.4404	75	6,3	24	3,5	VI (III)	VI	0,69	1,16	1,16	
16	1.4462	90	2	12	1,5	I	I _t	0,74	1,43	1,43	bolt failure
17	1.4462	90	2	12	2,5	VI (I)	IV	0,98	1,63	-	
18	1.4462	90	2	12	3,5	VI (II)	VI	1,05	1,75	1,75	
19	1.4462	90	2	12	4,5	VI (II)	IV	0,95	1,58	-	
20	1.4462	40	2	12	4,5	VI (III)	III	0,87	1,45	0,99	
21	1.4462	40	2	12	4,5	VI (III)	III	0,85	1,41	0,99	
22	1.4462	90	5,2	24	1,0	I	I _s	0,45	1,25	1,25	
23	1.4462	90	5,2	24	2,0	VI (I)	VI	0,73	1,21	1,21	
24	1.4462	100	5,2	24	3,5	VI (II)	VI	0,76	1,26	1,26	
25	1.4462	100	5,2	24	4,5	VI (II)	VI	0,75	1,26	1,26	
26	1.4404	90	2	12 (2L)	2,5	V	V	0,86	1,24	1,24	
27	1.4404	90	2	12 (3L)	2,5	V	III	0,73	1,09	0,86	
28	1.4404	90	2	12 (2L)	2,5	V	III	0,94	1,07	0,74	
29	1.4462	90	2	12 (2L)	2,5	V	III	0,91	1,30	0,72	
30	1.4404	80	2	12 (2T)	3,5	VI (III)	III	0,95	1,58	1,09	2 bolts transversely
31	1.4404	120	6,3	20 (2T)	3,5	VI (III)	VI	0,67	1,11	1,11	2 bolts transversely

Notes:
1) See Figure C.6.1. Mode IV excluded from predicted mode. Mode shown in brackets is next critical predicted mode after VI.
2) All α factors based on actual dimensions.
3) Net section failure load is taken as $A_{net} f_u$.

Inspection of the α factors will show that, for a single bolt specimen, mode II is not obtainable, as mode VI always intervenes. Indeed, this proved to be true because mode II never occurred. Nevertheless, it would appear that the margin of strength over and above the predicted failure load for mode VI is highly variable, and in some instances the predicted failure load for mode II also was exceeded.

The bearing stress at failure divided by the ultimate tensile strength of the material for each specimen is shown in Figure C.6.2, together with the design lines (with $\alpha = 1$) for modes I, II and VI. In all cases, the experimental value exceeds the design value (as can be seen in the tenth column of Table C.6.1). However this is only made possible by modifying the carbon steel rules for mode VI. In ENV 1993-1-1, this rule is worded to apply only to lap joints containing a single bolt (it is understood that this may not in fact be the intention). In specimen 31, containing two bolts, the critical mode would then become a net section failure for which $0,9 A_{net} f_u = 258$ kN, whereas only 253 kN was actually measured in the test. Although the shortfall is marginal (-2%), this result should be compared to other net section failure data which generally show an excess of +3% (+9% in the case of specimen 30). Since specimen 31 actually failed in mode VI, the carbon steel rules are extended from single bolt lap joints to include any number of bolts in a single line lying transversely to the direction of stress.

Specimens 26 to 29, comprising two or more bolts disposed in the direction of stress, demonstrate that summing the individual bolt loads leads to conservative design values for the connections' resistances. The relatively low utilisation of the net section strength is discussed under *Tension resistance*, below.

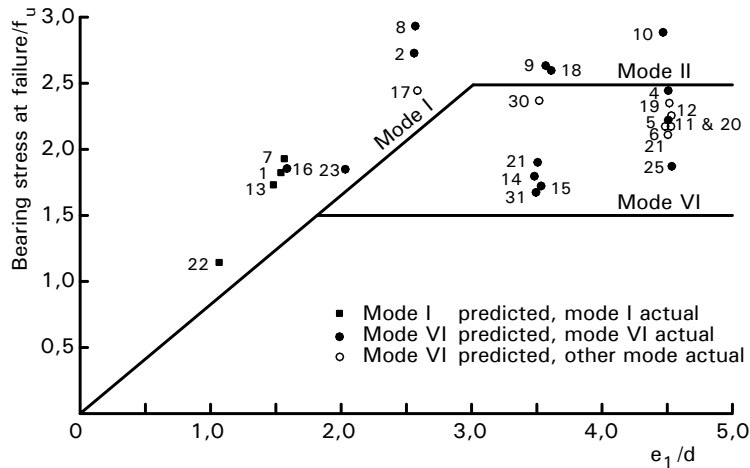

Figure C.6.2 Comparison of experimental data with design lines

The above is concerned with rupture, or extreme gross deformation, of the connection at the ultimate limit state. If the design rules were based on f_u , no rupture would occur but severe deformation would still be apparent at the ultimate limit state and an unacceptable level of deformation would exist at serviceability loads. The Recommendations therefore include provisions for using a reduced value of f_u (i.e. $f_{ur} = 0,5 f_y + 0,6 f_u$) to limit deformation. This formula has been derived by examining the loads at which the deformation is 3 mm for those specimens undergoing bearing deformation (i.e. specimens suffering net section failures are excluded). The formula is an approximation to the ‘best fit’ line through the data and the degree of fit is shown in Figure C.6.3. At the ultimate limit state, the deformation will be rather less than 3 mm because of the application of γ_{Mb} . At serviceability loads the deformation will be substantially less, due to the ‘absence’ of the load factor γ_F , and is likely to be of the order of 1 mm. This must be seen in the context of a possible slip of up to 2 mm (for M16 bolts and upwards) as the bolt goes into bearing.

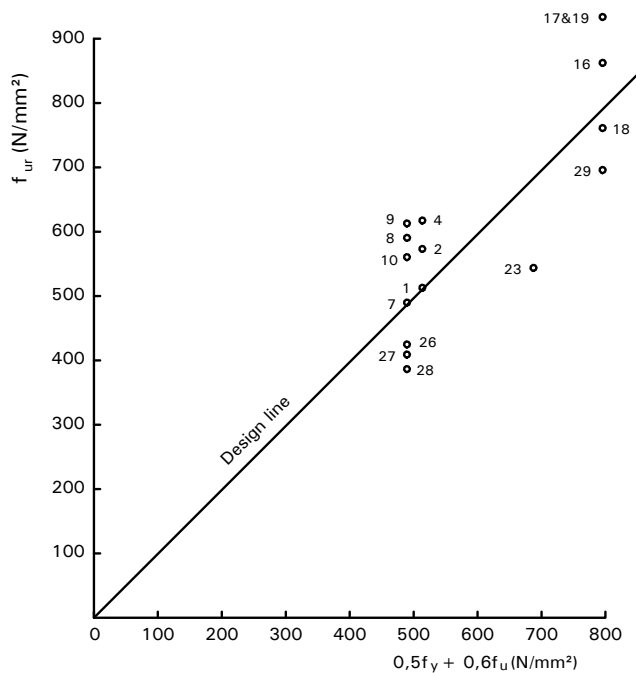

Figure C.6.3 Comparison of f_{ur} design line and experimental data

Errera et al^{98,17}

An investigation into the connection behaviour of thin gauge (up to approximately 1,5 mm thick) grade 1.4310 ½ hard stainless steel sheets was undertaken. (½ hard relates to a temper or strength obtained by work hardening in cold rolling. It is used in America but not in Europe.) The results of specimens which were reported to have failed in mode I or mode II are shown in Figure C.6.4. Although the material exhibited pronounced anisotropy, and almost all specimens were single shear lap specimens so that mode VI would play a part, the results generally support the findings reported in the tests carried out for the First Edition of the Design Manual.

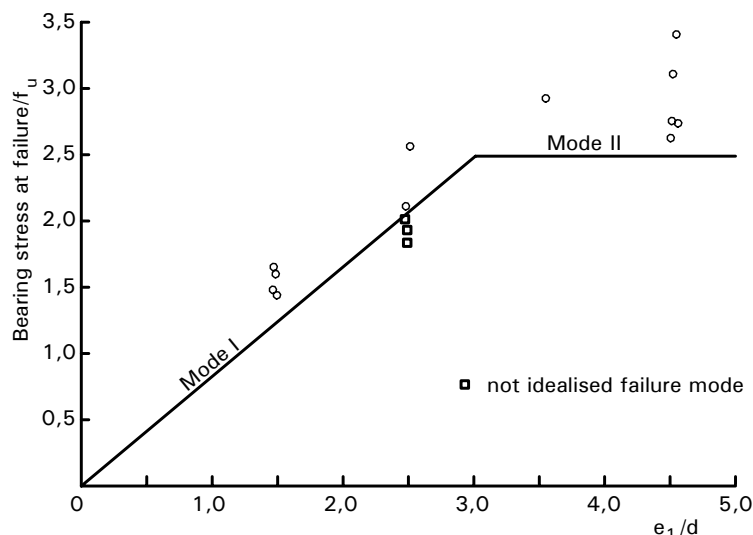

Figure C.6.4 Comparison of experimental data from Cornell University data with design lines¹⁷

*van der Merwe*⁹⁹

Some 66 tests on bolted connections in ferritic stainless steels (types 1.4016, 1.4512 and 1.4003) are reported. Single shear and double shear specimens, with and without washers, were designed to fail in either mode I, II or III. Most specimens had one or two bolts, though three had four bolts. Insufficient information is given to permit graphical representation. However, all mode I specimens (30 in number) exceeded the design values (with $\gamma = 1$) by ratios ranging from unity (for the 4 bolt specimens) to 1,84, with a mean at 1,38. The mode II specimens with washers again exceeded the design values but reduced bearing strengths were found for specimens without washers. The mode III results are discussed under *Tension resistance*, below.

*New test data from CTICM*¹⁰⁰

Tests were carried out on bolted cover plate connections in austenitic (grade 1.4306), duplex (grade 1.4462) and ferritic (grade 1.4016) stainless steels. Twelve cover plate connections with bolts in double shear were tested in each grade of steel. The number of bolts in the connections was varied from 2 (two different configurations) to 4. Table C.6.2 gives a summary of the test specimens and Table C.6.3 and Table C.6.4 gives the test results and predicted resistances for the tests on the austenitic and duplex grades.

The behaviour under test of this connection was typical of many of the other tests in austenitic and ferritic steels. Overall yielding of the gross section was first attained, followed by bearing failure. There was clear evidence of increased deformations occurring just beyond the predicted gross section yielding load. Final rupture was by bolt shear. The predicted ultimate net

section resistance of the connection was exceeded when failure of the bolts occurred. The specimen however had suffered significant necking at the net sections prior to failure. The bolt holes were considerably ovalised, indicating that bearing also contributed to the overall deformations of the specimen. The outer plies (cover plates) showed a pronounced ‘dishing’ effect in the part beyond the end bolt, i.e. the plate bends out from the central ply.

It was generally observed in these tests that the actual ultimate resistance of the net section always exceeded the calculated value by a significant amount (sometimes 20% or more). This may be partially explained by the high ductility of the stainless steels used, but further investigation of the actual steel strengths may be advisable.

The test results showed that the design expressions for bearing are safe. Higher bearing resistances for drilled holes were measured than those for punched holes. It was proposed that 1,75 mm permanent deformation of a cover plate connection is acceptable at the serviceability limit state and a 5 mm permanent bearing deformation is acceptable at the ultimate limit state.

The test programme also confirmed that the design rules for austenitic and duplex stainless steel bolted joints could be applied to ferritic stainless steels.

Table C.6.2 Summary of test specimens for the cover plate tests¹⁰⁰

Bolts	Holes	Connection Identification	e ₁	p ₁	d ₁	e ₂		p ₂	b	h
						mm				
M12x40	M14	A2L-12, F2L-12, D2L-12	22,5	45	55	22,5	-	45	190	
		A2T-12, F2T-12, D2T-12	22,5	-	55	22,5	45	90	100	
		A3-12, F3-12, D3-12	22,5	45	55	22,5	45	90	190	
		A4-12, F4-12, D4-12	22,5	45	55	22,5	45	90	190	
M16x50	M18	A2L-16, F2L-16, D2L-16	27,5	55	65	27,5	-	55	230	
		A2T-16, F2T-16, D2T-16	27,5	-	65	27,5	55	110	120	
		A3-16, F3-16, D3-16	27,5	55	65	27,5	55	110	230	
		A4-16, F4-16, D4-16	27,5	55	65	27,5	55	110	230	
M20x50	M22	A2L-20, F2L-20, D2L-20	35	70	80	35	-	70	290	
		A2T-20, F2T-20, D2T-20	35	-	80	35	70	140	150	
		A3-20, F3-20, D3-20	35	70	80	35	70	140	290	
		A4-20, F4-20, D4-20	35	80	80	35	70	140	290	
Plate nominal thickness (mm):			Central plate		Cover plate					
			Type A		5					
			Type F		4					
			Type D		6					

Specimen numbering system:

The first letter indicates type of steel (A = austenitic, D = duplex, F = ferritic). The number following gives the number of bolts in the connection. For the 2 bolt specimens, L indicates the bolts are parallel to the load direction, T indicates they are transverse to the load. The final 2 numbers give the bolt diameter.

Table C.6.3 Summary of test results and predicted resistances for cover plate tests on austenitic stainless steel¹⁰⁰

Steel:		Austenitic : nom = 5/10/5 mm ; meas. 5,2/9,85/5,2			
Strength		Austenitic 1.4306 = 304L: Measured f_y and f_u used			
Test Config.	A-2L	A-2T	A-3	A-4	
Bolt	Element	Calculated Resistance in kN : Gamma = 1,0			
12	Bolt shear	174,6	174,6	261,9	349,2
	Bearing	158,3/200,6	158,3	237,5/306,1	316,7/401,1
	Gross sect.	122	243,9	243,9	243,9
	Net section	162	322	322	322
	Serv.x1,5	126	252	252	252
	F_{u_Test}	173,9	179,4	269,6	345,6
Failure Mode(s)	Yield < Net sect. < Bolt shear	Bearing < Bolt shear	Yield < Bearing? < Bolt shear	Yield < net sect < bolt shear	
16	Bolt shear	359,8	359,8	539,8	719,7
	Bearing	200,7/251,8	200,7	301/397,7	401,4/503,5
	Gross sect.	149,1	298,1	298,1	298,1
	Net section	192,1	384,3	384,3	384,3
	Serv.x1,5	150	301	301	301
	F_{u_Test}	234,4	341,9	496	475,8
Failure Mode(s)	Yield < Net section Central plate fail.	Bearing < yield < Bolt shear	Yield < Net. < Bear Ext. plate failure	Yield < Net sect. (not full rupture)	
20	Bolt shear	501	501	751,5	1002
	Bearing	261,2/330,3	261,2	391,8/507,5	522,5/660,5
	Gross sect.	189,7	379,4	379,4	379,4
	Net section	249,3	498,5	498,5	498,5
	Serv.x1,5	195	390	390	390
	F_{u_Test}	297,1	444,5	583,6	580,9
Failure Mode(s)	Yield < Net sect. Central plate fail.	Bear. < Yield (not full rupture)	Yield. < Bear < Net (not full rupture)	Yield < Net sect. (not full rupture)	
Note:	Measured Yield and Tensile strengths used in N/mm ²				
			Yield 0,2%	Ult. Tensile	Elongation %
Steel Properties	5mm plate actual	Measured	271	577	63%
	5,2mm	Min specified	200	500	45%
	10mm plate actual	Measured	288	581	62%
	9,85 mm	Min specified	200	500	45%

Table C.6.4 Summary of test results and predicted resistances for cover plate tests on duplex stainless steel¹⁰⁰

Steel:	Thicknesses	Duplex 1.4462 : 6/12,5/6 mm			
Strength	Measured f_y and f_u used				
Test Config.	D-2L	D-2T	D-3	D-4	
Bolt	Element	Resistance in kN : Calculated with gamma of unity			
12	Bolt shear	174,6	174,6	261,9	349,2
	Bearing	357,7	282,4	568,8	715,5
	Gross sect.	297	594	594	/594
	Net section	255,1	364,3/510,2	510,2	510,2
	F_{u_Test}	192,2	188,7	280,3	373,9
Failure Mode	Bolt shear	Bolt shear	Bolt shear	Bolt shear	
16	Bolt shear	359,8	359,8	539,8	719,7
	Bearing	449,1	358	739	898,2
	Gross sect.	363	726	726	726
	Net section	304,5	609	609	434,8/609
	F_{u_Test}	357,9	361,7	534,3	581,3*
Failure Mode	Net sect. < Bolt shear	Bear. < Bolt shear	Bolt shear	*Test ended Net section?	
20	Bolt shear	501	501	751,5	1002
	Bearing	589,1	465,9	943	1178,2
	Gross sect.	462	924	924	924
	Net section	395	790	790	790
	F_{u_Test}	499	504,6	577,3*	580,9*
Failure Mode	Net sect. < Yld Cl. Plate	Bear. < Bolt shear	*Test ended Bolt shear ?	*Test ended < Net sect.?	
Note:	Measured Yield and Tensile strengths used in N/mm ²				
			Yield 0,2%	Ult. Tensile	Elongation %
Steel Properties	6mm plate actual 6,3	Measured Min specified	550 460	762 640	36% 25%
	12,5mm pl, Actual 12,85	Measured Min specified	590 460	770 640	not given 25%

Tension resistance

Two rules are provided for calculating the tensile resistance of connected parts in tension. The second of these limits the stress in the gross section to f_y in order to limit plastic deformation. Note that some plastic deformation (in fact 0,2%) would occur if the element were stressed to f_y .

The First Edition of the Design Manual gave the following expression for the ultimate resistance of the net cross-section at holes for fasteners:

$$N_{u,Rd} = \frac{0,9 k_r A_{net} f_u}{\gamma_{M2}} \quad \text{where } k_r = (1 - 0,9r + 3rd/s)$$

The k_r factor has long been used by the thin gauge cold formed design fraternity and relates to bolted connections with washers under both the bolt head and nut. The factor recognises the deleterious effect of the stress concentrations when the load in the member is taken out through a bolt (or bolts) as opposed to no load removal in a tension member just containing a hole. The latter situation may arise, for instance, in two diagonal bracings joined at their middle by a bolt (the bolt taking little or no load).

For a single bolt $r = 1$ and for two bolts (with the bolts aligned parallel to the direction of stress) $r = 1/2$, etc. The factor k_r is less than unity if d/s is 0,3 or smaller, no matter what value r may take.

The justification for using k_r for stainless steel is based on experimental data. In Table C.6.1, use of the k_r factor would change the experimental to predicted α ratios for the actual mode (eleventh column) for specimens 27, 28 and 29 from 0,86, 0,74 and 0,72 to 1,04, 0,99 and 0,96 respectively. These would then all be above unity when the 0,9 factor is introduced. Furthermore, with the 0,9 and k_r factors, specimens 27 and 28 would have been predicted to fail in the observed mode.

The net section failures of thin gauge type 1.4310 $\frac{1}{2}$ hard stainless steel connections in the series of tests carried out by Errera et al^{98,17} also indicate that the factor k_r is necessary, see Figure C.6.5. As can be seen, there is a substantial difference between the single shear and double shear specimens with 3 of the 4 single shear specimens falling below the characteristic design line. These low single shear results are all due to the effects of distortion in the thin gauge specimens and in fact are governed by failure mode VI (see Figure C.6.1). As such, it would be inappropriate to use these results to justify a lowering of the design curve. The double shear specimens, for which mode VI is not a possibility, corroborate the design recommendations for net failure.

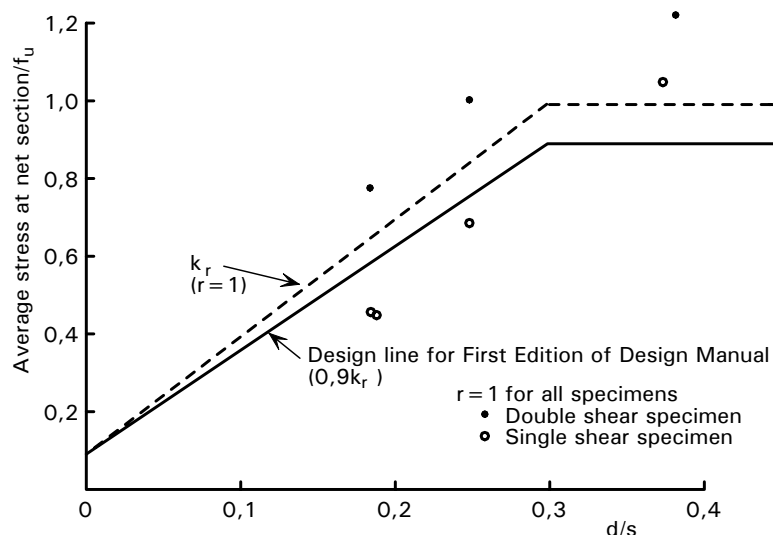

Figure C.6.5 Cornell University data for net section failure¹⁷

Figure C.6.6 shows the results for connections in ferritic stainless steel for specimens having washers under both bolt head and nut⁹⁹. All but one specimen had two bolts, for which $r = 0,5$. Again, a reduction in load is indicated for d/s values below 0,3.

However, the recent tests reported by Ryan¹⁰⁰ do not justify the retention of the 0,9 factor in addition to the k_r factor in the expression for the ultimate resistance of the net cross-section. The equivalent expression in ENV 1993-1-1 includes the 0,9 factor, but not the k_r term in the expression. Conversely, ENV 1993-1-3 includes the k_r term but does not include the 0,9 factor. The tests reported in Reference 97 indicated that the 0,9 factor may not be needed, although it was retained to maintain compatibility with ENV 1993-1-1, account for variables such as strain rate effects and limit gross deformation at the net section. It was therefore concluded during the drafting of the Second Edition of the Design Manual that there was sufficient evidence for removing the 0,9 factor from the expression for the ultimate resistance of the net cross-section. In the Second Edition, the expression for k_r was re-arranged and modified slightly to align with the definition given in ENV 1993-1-3 which includes the bolt hole diameter as opposed to the bolt diameter.

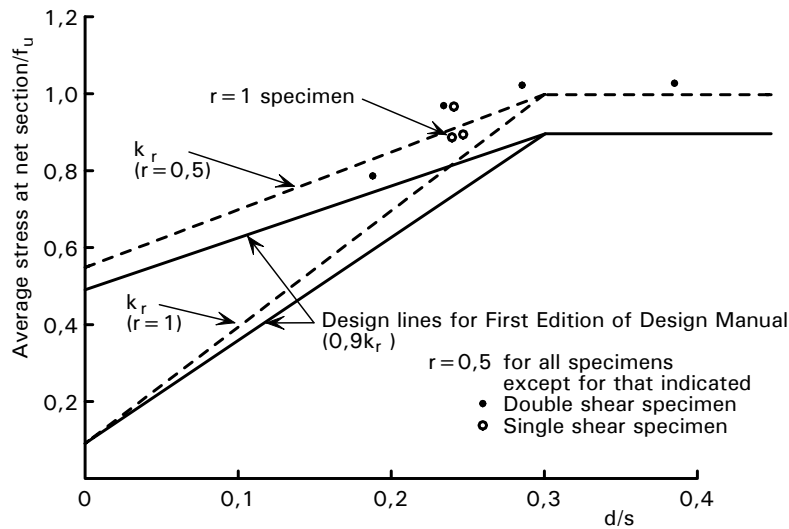

Figure C.6.6 Net section failure data by van der Merwe⁹⁹

Design for block tearing

There are no specific test data for stainless steel in shear rupture. Guidance in ENV 1993-1-1² is recommended.

Angles connected by one leg and other unsymmetrically connected members in tension

Ryan¹⁰⁰ tested bolted gusset plate connections to angle and tee sections in austenitic stainless steel. The twelve test specimens comprised tee or angle sections connected to one side of a gusset plate by bolts acting in single shear. Each specimen consisted of a 1500 mm length of section with a gusset plate bolted at each end. The specimens were loaded by applying tension to the gusset plates. The plates and sections were austenitic stainless steel grades 1.4306 and 1.4307. Some of the sections were cut from UPN type, I-sections or rectangular hollow sections. The number of bolts (A4 property class 80) in the connections varied from 4 to 8. Table C.6.5 gives a summary of the test specimens.

The test results were compared to the resistances predicted by two methods:

ENV 1993-1-4 and First Edition of the Design Manual

This approach allows the member to be treated as concentrically loaded provided the following expression for A_{net} is used to calculate the net section resistance:

$$A_{net} = \text{net area of connected leg} + 0,5 \text{ gross area of shorter leg}$$

ENV 1993-1-1

This approach calculates an effective concentrically loaded section that depends on the net section of the entire angle and on the number and spacing of the bolts. The rule is given in full in Section 6.2.3, Equations 6.6, 6.7 and 6.8.

Table C.6.6 summarises the test results and predicted resistances. For the reinforced angle connections, the following modifications were made to the ENV 1993-1-1 and ENV 1993-1-4 rules to allow for the fact that the outstand leg was also attached to the gusset via a cleat:

- In the ENV 1993-1-1 method, the β factor was taken as 0,7 (the highest value proposed for angles attached by one leg).
- In the ENV 1993-1-4 method, the efficiency of the outstanding leg area was increased from 50% to 70%.

Table C.6.5 Test specimens for gusset plate tests¹⁰⁰

Test	Section	Bolts	Remark
C1-6/20	Angle 100x100x10	6 M20-1 line	Staggered row of bolts
CR1-4/20	Angle 100x100x10	Line of 2 M20 on each leg	Reinforced by a cleat Cleat with 2M20 to gusset
CR2-6/20	Angle 100x100x10	Line of 3 M20 on each leg	Reinforced by a cleat Cleat with 3M20 to gusset
UC1-4/20	Angle 80x65	4 M20 - 1 line	Section cut from UPN 160x65 -65mm leg bolted
UCR1-4/20	Angle 80x65	Line of 2 M20 on each leg	Section cut from UPN 160x85 Cleat with 2M20 to gusset
UCR2-6/20	Angle 80x65	Line of 3 M20 on each leg	Cut from UPN 160x85 Cleat with 3M20 to gusset
RC1-3/16	Angle 110x50x4	3 M16 - 1 line	Section cut from 120x60x4 rect.tube- 110mm leg bolted
RC2-4/16	Angle 110x50x4	2 lines of 2 M16 on attached leg	Section cut from 120x60x4 rect.tube- 110mm leg bolted
T1-6/12	T 100x100x10	2 lines of 3 M12	Flange bolted
T2-8/12	T 100x100x10	2 lines of 4 M12	Flange bolted
IT-4/12	T 80x82	2 lines of 2 M12	Cut from I 160x82 82 mm flange bolted
IT-8/12	T 80x82	2 lines of 4 M12	Cut from I 160x82 82 mm flange bolted

Table C.6.6 Summary of test results and predicted resistances for gusset plate tests¹⁰⁰

Test	Predicted ultimate resistances kN				Comparison of ENV 1993-1-4 with tests results			
	Bearing	Bolt shear	Net** Section Part 1-4	Net** Section Part 1-1	Pred.*** Resist.kN Part 1-4	Test kN	Ratio of Test/Pred. for actual failure modes	Failure mode
C1	803,5	751,5	755,8	514,1	751,5	642	0,854**	Net section
CR1	559,7	501	773,0*	626,5*	501	322	0,643	Bolt shear
CR2	839,5	751,5	773,0*	626,5*	751,5	556,7	0,741	Bolt shear
UC1	629,2	501	448,7	298,2	448,7	441,8	0,985**	Net section
UCR1	629,2	501	438,1*	322,2*	438,1*	339,5	0,678	Bolt shear
UCR2	943,8	751,5	431,2*	320,4*	431,2*	514,9	1,194**	Net section
RC1	177,0	269,9	376,7	245,4	177/269,9	275	1,554/1,019	Bearing/bolt shear
RC2	236,0	359,8	317,5	274,1*	236/317,5	308,6	1,308/0,972	Bearing/Net sect. **
T1	489,5	261,9	642,7	499,7	261,9	274,9	1,050	Bolt shear
T2	652,6	349,2	642,7	499,7	349,2	356,2	1,020	Bolt shear
IT1	328,0	174,6	620,4	400,4	174,6	162,2	0,929	Bolt shear
IT2	655,9	349,2	623,6	462,8	349,2	369,8	1,059	Bolt shear

Notes :

- * By modified ENV rule
- ** Without 0,9 factor
- *** Not necessarily for the failure mode

The test results showed that the guidance in ENV 1993-1-4 may be unsafe and would lead to excessively large permanent deformations in some cases, possibly even at the serviceability limit state. The ENV 1993-1-4 guidance always gives higher resistances than the guidance in ENV 1993-1-1, in particular for many standard angles with short connections, for which it predicts resistances up to twice those predicted by the ENV 1993-1-1 guidance. However, the guidance in ENV 1993-1-1 showed acceptable agreement with the test results, although it did not always properly account for the length of the connection. It therefore replaces the ENV 1993-1-4 rule in the Second Edition of the Design Manual.

C.6.2.4 Fasteners

Net areas

The tensile stress areas for stainless steel bolts to EN ISO 3506⁶ are set out in Table C.6.7.

Table C.6.7 *Tensile stress area for bolts to EN ISO 3506*

Thread Size (Coarse Series)	Stress Area, A_s (mm ²)
M6	20,1
M8	36,6
M10	58,0
M12	84,3
M16	157,0
M20	245,0
M24	353,0
M30	561,0
M36	817,0

Bearing resistance

The bearing strength of a bolt is rarely critical in carbon steel structures. In stainless steel, however, the high ultimate tensile strength of the plies will make the bearing strength of bolts more often the governing criterion. The provision in the Recommendations is derived from ENV 1993-1-1.

Shear, tension and shear/tension resistance

The recommendations given in these sections are all similar to rules given in ENV 1993-1-1 for common structural bolts.

A limited test programme on the strength of stainless steel bolts was conducted to generate information for the First Edition of the Design Manual⁹⁷. The number and type of tests are set out in Table C.6.8 and the results are summarised in Figure C.6.7.

Table C.6.8 Number of tests on stainless steel bolts

Fastener (set screws)	Key to Fig C.6.7	Supplier								
		A			B			C		
		T	S	T/S	T	S	T/S	T	S	T/S
M20, A4-80		8	8	8	5	5	5	8	3	2
M16, A4-80	•	8	7		5	5		2		
M16, A4-70								6	2	

Notes:

T = Tension test, S = double shear test

T/S = Combined tension and shear

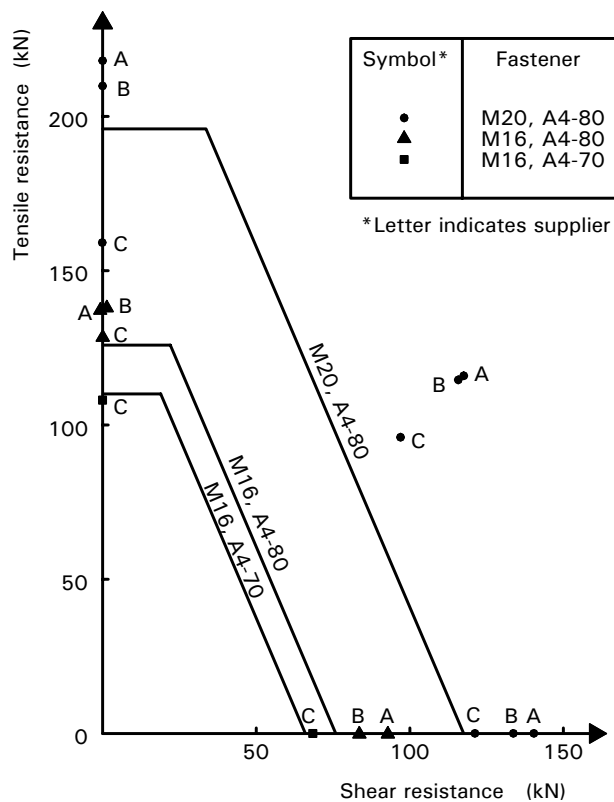

Figure C.6.7 Results of tests on stainless steel bolts

The lines of Figure C.6.7 correspond to the interaction formula given in Section 6.2.4 *Combined shear and tension* but using the specified tensile capacity⁶ for the ordinate and 0,6 times that for the abscissa. (The provision in 6.2.4 *Tensile resistance* applies a 0,9 scaling factor to the ordinate.)

Given any particular batch and test type, the results were remarkably consistent, typically within ± 2 kN for tension and ± 5 kN for shear about the respective averages. Tests at loading rates differing by an order of magnitude showed little effect on failure loads.

In one instance (supplier C of M20 A4-80 set screws), the measured tensile capacity is less than the minimum specified level. This led to the recommendation in 3.1.2 to have samples independently tested. Nevertheless, even this batch was satisfactory in pure shear and in combined tension and shear (for the ratio tested, $T = S$).

More recently, Ryan¹⁰⁰ carried out tension and shear tests on individual bolt/nut assemblies. Some of the shear tests were carried out with the plates loaded in tension, and some in compression. Bolt diameters M12, M16 and M20 were tested; all the bolts were austenitic A4 property class 80 to EN ISO 3506. The results of the bolt tension and shear tests showed good agreement with the predicted values.

Long joints and large grip lengths

The shear flow in long joints is such that the fasteners at each end take more shear than the average shear of all the fasteners. Since stainless steel is more ductile than carbon steel, and hence permits a greater degree of force redistribution, stainless steel long joints should be at least of equal performance to those in carbon steel.

Likewise, there is no reason to think stainless steel bolts with large grip lengths behave any worse than normal structural bolts.

C.6.3 Welded connections

The Recommendations adopt the approach for determining the strength of a fillet weld for carbon steel given in ENV 1993-1-1. Additionally, recommendations are given against the use of intermittent welds and partial penetration butt welds in certain circumstances, to reduce the potential for corrosion.

The provisions are primarily intended for sheet and plate of 4 mm thickness and over.

It is important that good quality welds are made using verified procedures, see Section 10.4, for the provisions to be realised.

Tests by SCI for the First Edition of the Design Manual

Since there were no available data on welded joints in the relevant grades of stainless steel when the First Edition of the Design Manual was being written, a limited test programme was conducted⁹⁷. The fifteen specimens included a variety of different types of joints as shown in Table C.6.9.

Only full penetration butt weld tests were carried out on grades 1.4307 and 1.4404 material. Welds in duplex 1.4462 material were tested in all configurations. All specimens were prepared individually, without using run-off tabs, so that starting and finishing defects would be present. The results generally confirm the assertion that the strength of a weld may be considered as equal to the parent material. The lowest ratio of measured failure load to predicted failure load is 0,91 for specimen 7. Some of this discrepancy may be attributed to strain rate effects, as some specimens that failed away from the weld only reached a ratio of 0,95.

Tests on grade 1.4310 and ferritic stainless steels

References 98, 17 and 99 contain results of weld test programmes. References 98 and 17 report on a test programme on ¼ hard and ½ hard 1.4310 stainless steel and Reference 99 reports on ferritic stainless steels. The tests on the 1.4310 material show that the welding process has a partial annealing effect on the cold worked stainless steel with a consequent reduction in the cold worked strength.

Table C.6.9 *Welded connection test programme*

Specimen Number	Steel Grade	t (mm)	Weld Throat a (mm)	Measured Load	Schematic
				Predicted Load	
1	1.4307	4,2	Full Pen.	0,97	
2	1.4307	10,4	Full Pen.	0,95	
3	1.4404	4,2	Full Pen.	1,03	
4	1.4404	10,4	Full Pen.	0,97	
5	1.4462	2,0	1,4	1,00	
6	1.4462	10,6	7,1	0,92	
7	1.4462	2,0	1,4	0,91	
8	1.4462	10,6	7,1	-	
9	1.4462	2,0	1,4	0,99	
10	1.4462	10,6	7,1	0,96	
11	1.4462	10,6	5,0	1,08	
12	1.4462	10,6	3,9	1,02	
13	1.4462	10,6	2,6	1,09	
14	1.4462	10,6	3,5	1,06	
15	1.4462	10,6	Full Pen.	0,96	

Tests by RWTH

More recently, 46 stainless steel fillet welded connections were tested at RWTH¹⁰¹. The test programme comprised 22 single lap joints with welds parallel to the loading direction, and 24 double lap joints with welds transverse to the loading direction. Two different base material grades with two electrode material grades were tested: grade 1.4301 base material with grade 1.4316 electrodes, and grade 1.4462 base material with grade 1.4462 electrodes. Tensile coupon tests in accordance with EN 10002-1¹⁰² were conducted on the base material (with coupons prepared both transversely and longitudinally to rolling direction), on the electrode material, and on the actual weld material.

The approach for determining the strength of a fillet weld in the Recommendations is that for carbon steel given in ENV 1993-1-1, but with the correlation factor, β_w set to 1,0 for all grades of stainless steel. For the RWTH tests, the ratios of experimental failure load to predicted failure load were calculated. These ratios were much higher for welds transverse to the load direction (varying from 1,42 to 1,69) than for those parallel to the load direction (varying from 1,01 to 1,12). This behaviour is also apparent with carbon steels. In ENV 1993-1-1 different β_w values are given for different grades of carbon steel and β_w is independent of the weld configuration. Statistical analysis of the SCI and RWTH test results concluded that $\beta_w = 1,0$ should be used for determining the resistance of stainless steel fillet welded connections¹⁰¹. This approach is very conservative for welds that are transverse to the direction of loading, but economic for longitudinal welds.

C.7 FIRE RESISTANT DESIGN

C.7.1 General

The Eurocode covering fire resistant design of structural carbon steel, ENV 1993-1-2 *Structural fire design*⁴⁹ did not cover stainless steel in any detail apart from making reference to some high temperature strengths given in EN 10088. European fire design guidance for carbon steels was subsequently developed further by Krupp et al in the *ECCS Model code on fire engineering*¹⁰³. This document was used extensively during the conversion of ENV 1993-1-2 to prEN 1993-1-2¹⁰⁴. Guidance in this Section closely follows that given in this latter document. For the purposes of design, it is assumed that the actions are taken from ENV 1991-2-2¹⁰⁵.

C.7.2 Mechanical properties at elevated temperatures

The derivation of the mechanical properties at elevated temperatures given in the Recommendations is fully reported by Zhao¹⁰⁶. Tests were carried out on five grades of stainless steel: 1.4301, 1.4401, 1.4571, 1.4462 and 1.4003. The test programme consisted of tensile tests at room temperature, isothermal tests at elevated temperature and anisothermal tests at elevated temperatures. Based on the test results, a mathematical model was generated for describing the stress-strain relationship for stainless steel at elevated temperatures. The model is closely aligned to the model for carbon steel in References 49 and 104 and is divided into two non-linear parts, (strains from zero to e_c , and strains from e_c to e_u), as shown in Figure C.7.1 and Table C.7.1. From the model, the strength and stiffness retention factors were generated for the grades tested (given in Table 7.1 of the Recommendations).

The advantages of this model are that it gives an accurate prediction of the stress-strain relationships of stainless steel at elevated temperatures, whilst remaining compatible with the familiar carbon steel model from ENV 1993-1-2.

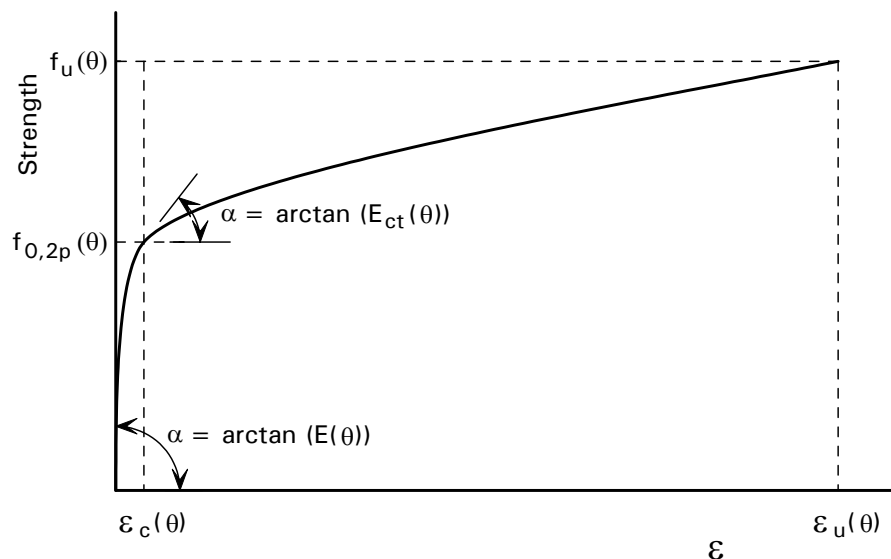

Figure C.7.1 Definition of stress-strain parameters

Table C.7.1 *Mathematical stress-strain model*

Strain range ε	Stress σ	Tangent Modulus E_t
$\varepsilon \leq \varepsilon_c$	$\frac{E \varepsilon}{1 + a\varepsilon^b}$	$\frac{E (1 + a\varepsilon^b - ab\varepsilon^b)}{(1 + a\varepsilon^b)^2}$
$\varepsilon_c \leq \varepsilon \leq \varepsilon_u$	$f_{0,2p} - e + \frac{d}{c} \sqrt{c^2 - (\varepsilon_u - \varepsilon)^2}$	$\frac{d + (\varepsilon_u - \varepsilon)}{c \sqrt{c^2 - (\varepsilon_u - \varepsilon)^2}}$

where:

$$a = \frac{(E \varepsilon_c - f_{0,2p})}{f_{0,2p} \varepsilon_c^b} \quad b = \frac{(1 - E_{ct} \varepsilon_c / f_{0,2p}) E \varepsilon_c}{(E \varepsilon_c / f_{0,2p} - 1) f_{0,2p}}$$

$$c^2 = (\varepsilon_u - \varepsilon_c) \left(\varepsilon_u - \varepsilon_c + \frac{e}{E_{ct}} \right) \quad d^2 = e (\varepsilon_u - \varepsilon_c) E_{ct} + e^2$$

$$e = \frac{(f_u - f_{0,2p})^2}{(\varepsilon_u - \varepsilon_c) E_{ct} - 2(f_u - f_{0,2p})} \quad \text{with } \varepsilon_c = f_{0,2p} / E + 0,002$$

$f_{u,\theta}$ is the tensile strength at temperature θ
 $f_{0,2p,\theta}$ is the 0,2% proof strength at temperature θ
 E_θ is the slope of the linear elastic range
 $E_{ct,\theta}$ is the slope at the 0,2% proof strength
 $\varepsilon_{c,\theta}$ is the total strain at the 0,2% proof strength
 $\varepsilon_{u,\theta}$ is the ultimate strain

Tensile tests on cold formed stainless steel at elevated temperatures reported by Ala-Outinen¹⁰⁷ showed that the increased strength due to the cold forming process remains constant up to 600°C, after which the strength begins to decrease and the influence of cold forming totally disappears at 900°C.

C.7.3 Thermal properties at elevated temperatures

The thermal properties have been taken from those given in Reference 104. A comparison of the thermal properties of stainless steels with those of carbon steels is given by Ala-Outinen¹⁰⁷ has compared the. Note that the thermal elongation values apply to austenitic stainless steel and not to duplex grades. Data for duplex grades should be sought from a stainless steel producer.

C.7.4 Determination of structural fire resistance

The behaviour of unprotected stainless steel beams and columns in fire was studied by Baddoo and Gardner¹⁰⁸. Fire tests were carried out on six stainless steel columns and four stainless steel beams. All the members were grade 1.4301 stainless steel. Four of the columns were fixed and two were pinned. Three of the beams were simply supported and one was continuous over two spans. The fire tests on four of the columns and two of the beams were subsequently modelled using finite element analysis. Reasonably good agreement was obtained between the test results and numerical analysis. A parametric study analysed the effects of varying the overall slenderness of columns, the load ratio (the applied load divided by the room temperature resistance) and the cross-sectional slenderness.

Using the material properties for stainless steel derived in Reference 106, design guidance for carbon steel in prEN 1993-1-2¹⁰⁴ was shown to be applicable to stainless steel columns (cold formed open and hollow cross-sections only) and

stainless steel beams supporting a concrete slab. Figure C.7.2 shows the column design curves against the results of the tests and numerical analyses. (A family of design curves is needed because the critical temperature is a function of both load ratio and non-dimensional slenderness, $\bar{\lambda}$.) Figure C.7.3 shows the beam design curves against the results of the tests and numerical analyses.

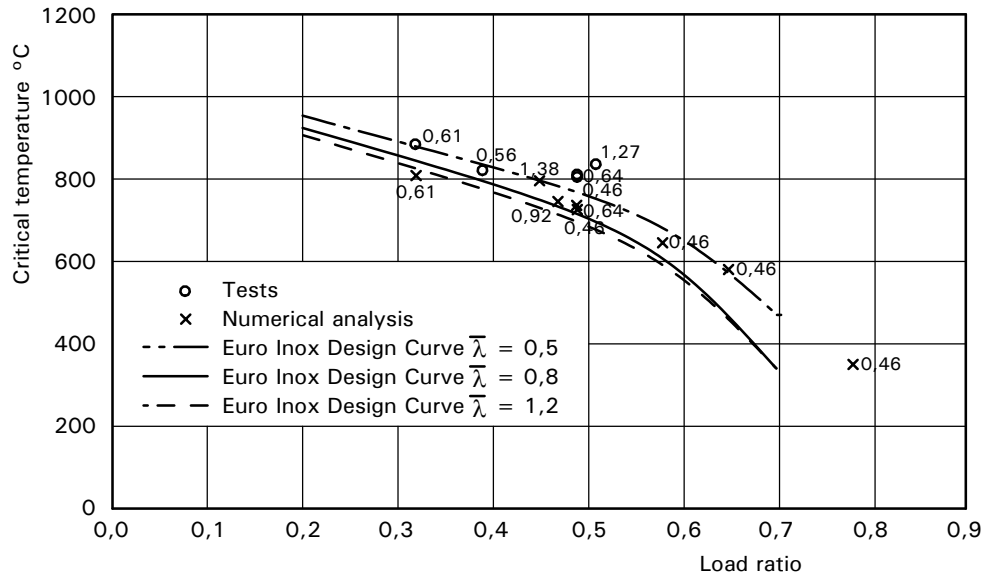

Note: Values of $\bar{\lambda}$ given next to each test and FE point

Figure C.7.2 Test data, results of numerical analyses and design curve for stainless steel columns

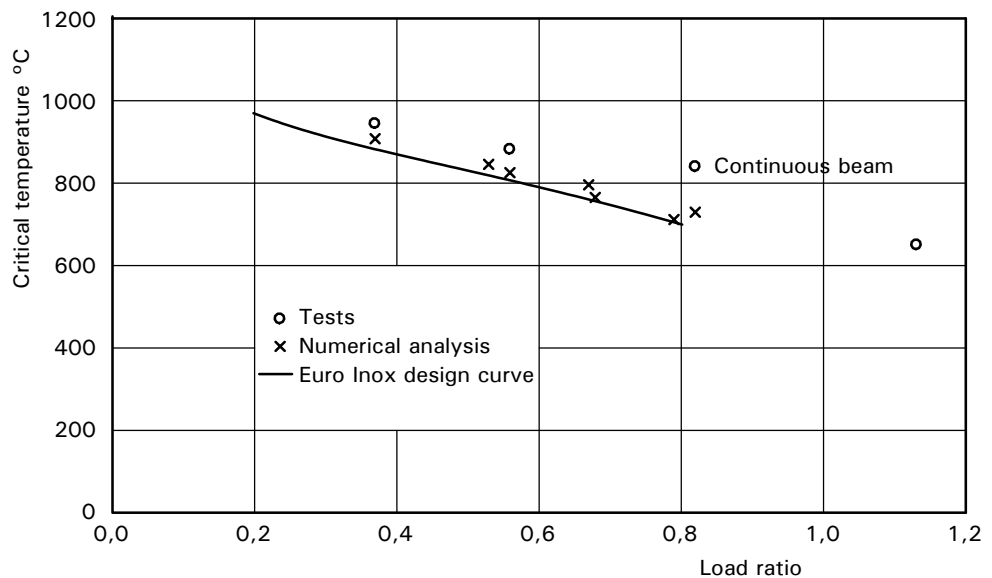

Figure C.7.3 Test data, results of numerical analyses and design curve for stainless steel beams

However, for the column tested with a welded, open cross-section, this design approach was found to over-estimate the measured resistance and further work is necessary before definitive design recommendations can be made for stainless steel columns with this type of cross-section.

Although there are no relevant test data, the Recommendations also give guidance on the:

- shear resistance,
- lateral torsional buckling resistance and
- resistance to combined axial compression and bending

of stainless steel members in fire, based on the recommendations for carbon steel in Reference 104.

Note that in determining the structural fire resistance for all modes of loading of stainless steel members with Classes 1, 2 and 3 cross-sections, the characteristic strength at 2% total strain is used in place of the 0,2% proof strength at ambient temperature. This is in accordance with the approach taken by prEN 1993-1-2 for carbon steel. Fire tests on structural members indicate that the strain at failure is strongly dependent on the loading mode. For example, beams supporting concrete or composite floors experience very high strains at failure (>2%). Load tests on columns show they behave rather differently in that relatively low strains are experienced at failure. It is conventional Eurocode practice to use empirical factors to adjust the applied loads (or the resistances) to obtain better agreement between tests and the basic material properties at 2% strain.

Very limited test data is available for stainless steel (or, indeed, carbon steel) columns with Class 4 cross-sections in fire. One fire test on a Class 4 hollow section was reported in Reference 108. Following the design procedure for Class 1-3 cross-sections, but using effective cross-section properties, led to a significant under-prediction of the buckling resistance. However, the shortage of test data led to the recommendation that for Class 4 cross-sections, the resistance should be calculated using the strength at 0,2% proof strain at a given temperature, and not the strength at 2% strain. This is similar to the procedure in prEN 1993-1-2, Annex E, which gives a lower set of strength retention factors for Class 4 cross-sections.

Earlier fire tests are reported by Ala-Outinen and Oksanen¹⁰⁹. They tested six 40x40x4 mm RHS columns in grade 1.4301 stainless steel with a buckling length of approximately 890 mm. They also studied the behaviour of butt welded joints at elevated temperatures, concluding that the joints did not have an adverse effect on the behaviour of the member in fire.

The heating up characteristics of a range of stainless steel sections with section factors varying from around 200 m⁻¹ to 700 m⁻¹ were studied in a test programme¹⁰⁸. Numerical modelling agreed well with the tests. Furthermore, it was shown that for a given section factor, a stainless steel section heats up at a very similar rate to a carbon steel section. Section 7.4.7 of the Recommendations is identical to the approach given for carbon steels in prEN 1993-1-2.

For advanced calculation methods, the guidance given in prEN 1993-1-2 can be followed.

C.8 FATIGUE

C.8.1 Introduction

Austenitic and duplex stainless steels are widely used in the fabrication of structures that are subjected to repeated loading and must therefore be designed to avoid fatigue failure. Many fatigue data exist for welded joints in structural carbon steels¹¹⁰. There is also an increasing body of stainless steel data^{111,112,113}.

Fatigue behaviour of welded joints is dominated by joint geometry. Similar crack growth behaviour occurs in carbon and stainless steel. The test data show that welded joints in stainless steel have fatigue strengths very similar to those in carbon steels and well established design rules for carbon steels are applicable to stainless steels.

The guidance on fatigue strengths apply to structures operating under normal atmospheric conditions and with sufficient corrosion protection and regular maintenance. The effect of seawater corrosion is not covered. Microstructural damage from high temperatures (> 150°C) is not covered. Furthermore, almost all the fatigue tests on stainless steel joints which were found in the literature had been performed in air. In the presence of a corrosive environment, fatigue strength is reduced, the magnitude of reduction depending on materials, environment, loading frequency etc. The effect of sea water on carbon steel, which has been most widely investigated, is to reduce fatigue life by a factor of 2 under freely corroding conditions.

The fatigue strength of welded joints is usually determined by a fatigue life-stress range curve, a so-called *S-N* curve, which is presented as a log-log graph. In Eurocode terminology, *S-N* curves are known as $\Delta\sigma_R-N_R$ curves. A fatigue strength curve is applied to each detail category. Each detail category is designated by a number that represents, in N/mm², the stress range that corresponds to a fatigue strength of 2 million cycles. For example, a joint assigned a detail category 80 (also designated FAT 80) would have a fatigue life of 2 million cycles when subject to a constant amplitude stress range of 80 N/mm².

C.8.2 S-N data for stainless steels

In a recent test programme, fatigue strengths of shielded metal arc welded (SMAW) joints from stainless steel grades 1.4301, 1.4436 and 1.4462 were determined using constant amplitude loading and axial tension fatigue tests¹¹⁴. Results from more than 50 test specimens were analysed. Test specimens were longitudinal and transverse non-load carrying fillet welds. As there are no standard S-N curves for stainless steel, the test results were compared to the carbon steel fatigue class given in prEN 1993-1-9¹¹⁵ (FAT 80 for transverse fillet welds and FAT 71 for longitudinal fillet welds). The results are shown in Figure C.8.1 and Figure C.8.2. The test results were analysed to determine the characteristic fatigue class FAT_{95%} (the stress range at a 95% survival probability). The characteristic fatigue classes exceeded the carbon steel standard classes.

Other test programmes generally support this behaviour^{116,117,118} although some test programmes have shown the class of austenitic stainless steel longitudinal fillet welds to be slightly lower than that of carbon steel^{119,120}. However, more recent studies have not confirmed this (Figure C.8.3), throwing some doubt on

the earlier sets of results, both of which happened to be obtained at the same laboratory in the 1970s. Thus the general trend is to apply fatigue design rules for carbon steels to welded stainless steels (excluding environmental considerations)¹¹⁷. This is the approach adopted in prEN 1993-1-9¹¹⁵.

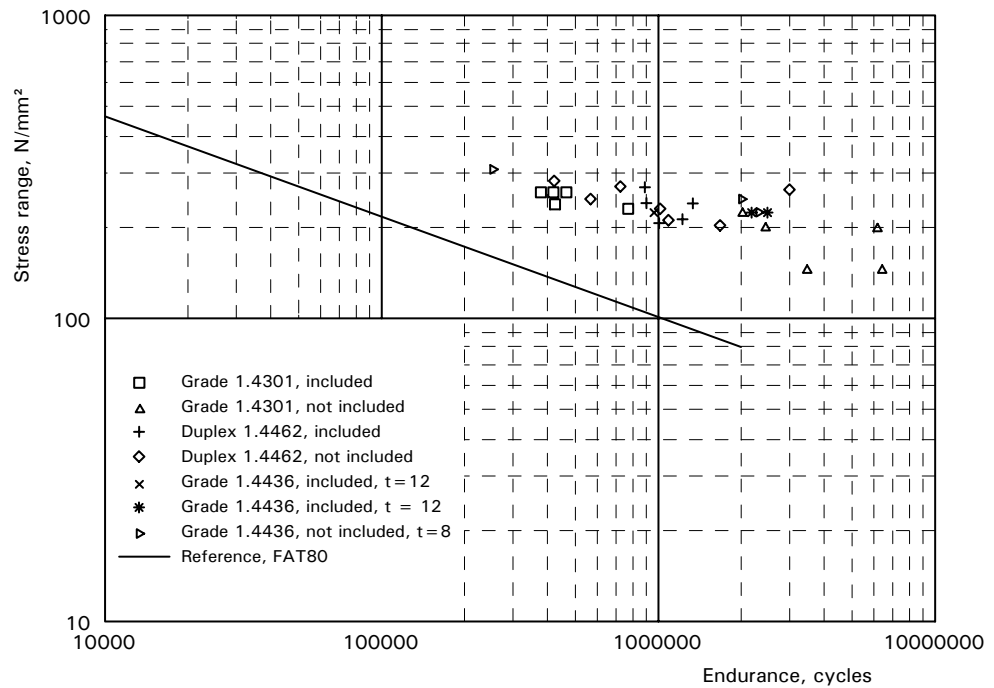

Figure C.8.1 Fatigue endurance data for transverse fillet welds (grades 1.4301, 1.4436 and 1.4462)

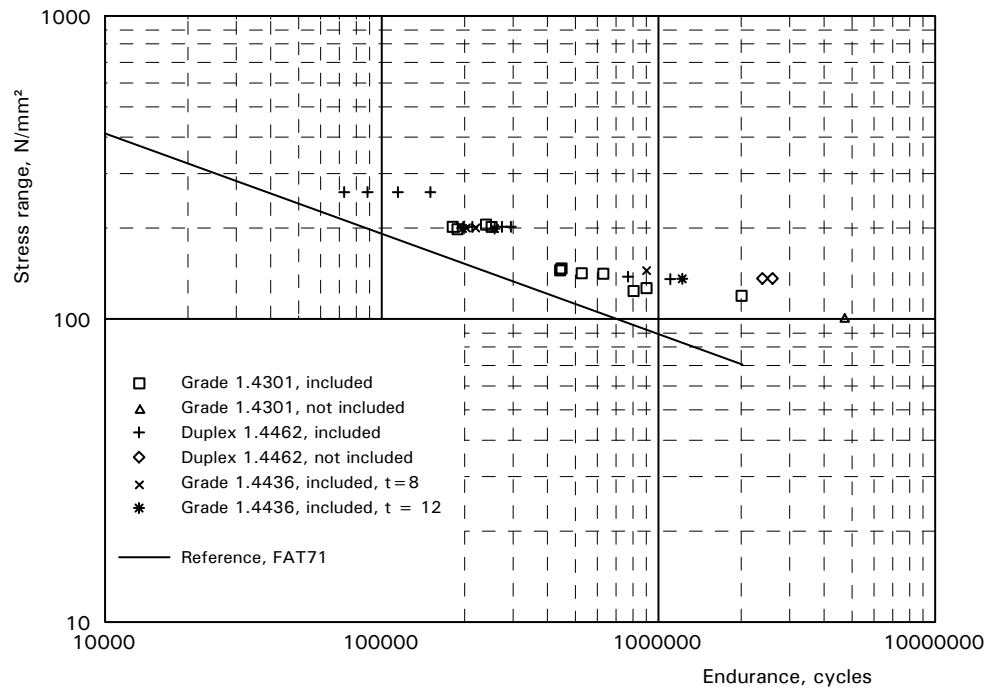
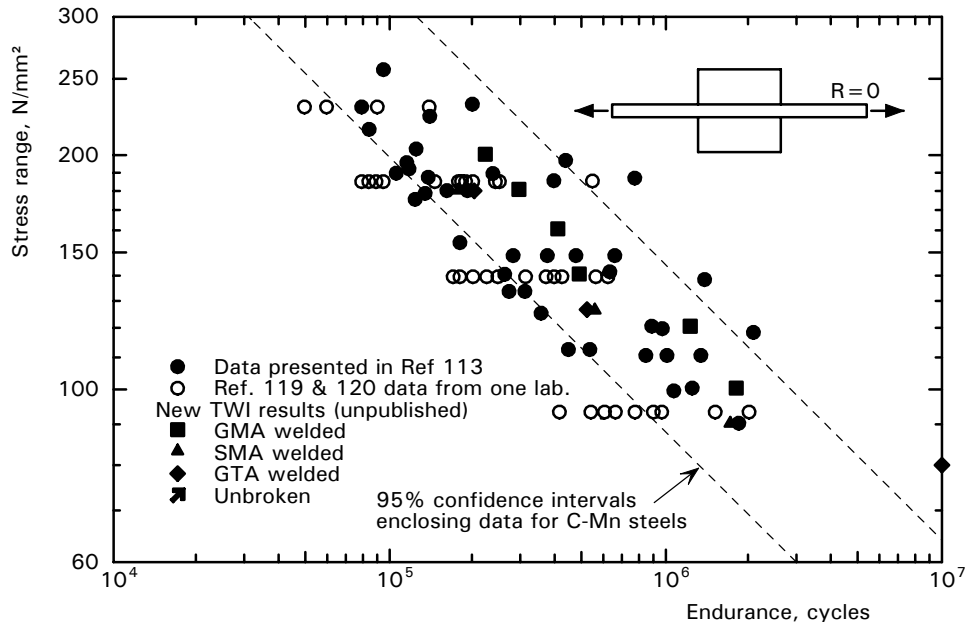

Figure C.8.2 Fatigue endurance data for longitudinal fillet welds (grades 1.4301, 1.4436 and 1.4462)



Note: 95% confidence intervals are taken from Reference 121

Figure C.8.3 *Fatigue test results for austenitic stainless steel plates with longitudinal fillet welded attachments*¹¹⁷

C.8.3 Fatigue crack growth data for stainless steels

An alternative method, although less commonly used, for fatigue assessment is the fracture mechanics approach. It is based on the observed relationship between the range in the stress intensity factor, ΔK , and the rate of growth of fatigue cracks, da/dN . This usually takes a sigmoidal form in a log ΔK versus log da/dN plot. Below a threshold stress intensity factor range, ΔK_{th} , no crack growth occurs. For intermediate values of ΔK , growth rate is idealised by a straight line in the log/log plot such that:

$$\frac{da}{dN} = C (\Delta K)^n$$

For a crack at the toe of a welded joint:

$$\Delta K = M_k Y \Delta S \sqrt{\pi a}$$

where

ΔS is the applied stress range,

a is the crack depth,

Y is a correction function dependent on crack size, shape and loading

M_k is a special function that allows for the stress concentration effect of the welded joint and depends on crack size, plate thickness, joint geometry and loading.

Solutions for Y for semi-elliptical cracks of the type which occur at the toes of welds and solutions for M_k for a range of welded joint geometries are available.

Combining the above two equations and integrating gives:

$$\int_{a_i}^{a_f} \frac{da}{(M_k Y \sqrt{\pi a})^n} = C \Delta S^n N$$

where

a_i is the initial crack depth

a_f is the final crack depth corresponding to failure

Thus, if a welded joint contains a crack or crack-like flaw, its fatigue life can be predicted assuming that the life consists of fatigue crack growth from the pre-existing crack, if the initial crack size is known.

Following a review of data pertaining to the fatigue crack growth behaviour of stainless steels, values of C and n are given in Table C.8.1. It is recommended to use a ΔK_{th} value of 63,2 N/mm^{3/2} (2MN/m^{3/2}) for all grades of stainless steel.

Table C.8.1 Values for C and n (in air)

R Range	C			n
	Upper 95% confidence limit	Mean	Lower 95% confidence limit	
0 < R ≤ 0,1	4,75 × 10 ⁻¹⁵	2,31 × 10 ⁻¹⁵	1,12 × 10 ⁻¹⁵	3,66
R = 0,5	1,60 × 10 ⁻¹⁴	8,57 × 10 ⁻¹⁵	4,53 × 10 ⁻¹⁵	3,60

Notes:

1. R = algebraic stress ratio, f_{min} / f_{max} (tension positive)
2. $da/dN = C(\Delta K)^n$
3. ΔK in N/mm^{3/2}, da/dN in mm/cycle
4. Valid for $300 \leq K \leq 1800$ N/mm^{3/2}

Figure C.8.4 shows the crack propagation data obtained for stainless steels in air below 100°C. The scatter band for crack growth data obtained from carbon steel¹²² is also shown for comparison. Fatigue crack growth behaviour of type 1.4301 and comparison of type 1.4301 with 1.4401¹²³ are illustrated in Figure C.8.5 and Figure C.8.6 respectively. Propagation data relating specifically to duplex 1.4462¹²⁴ are shown in Figure C.8.7.

The review of data on crack growth behaviour in air below 100°C indicates that the growth rates in stainless and carbon steel are similar (as shown in Figure C.8.4). This suggests that the well established Paris Law coefficients n and C for carbon steels¹²² may be used for the fracture mechanics analysis of stainless steels (Table C.8.1).

A review of threshold stress intensity factors ΔK_{th} for the stainless steel types was also carried out¹²⁵ and the results are tabulated in Table C.8.2 and illustrated in Figure C.8.8. These values are similar to those for carbon steels. The recommended value of $\Delta K_{th} = 2\text{MN/m}^{3/2}$ for use with welded structures is a lower bound to the values in Table C.8.2 and Figure C.8.8 (and in particular to higher values of R) and is the same as that used for the assessment of crack behaviour in carbon steels.

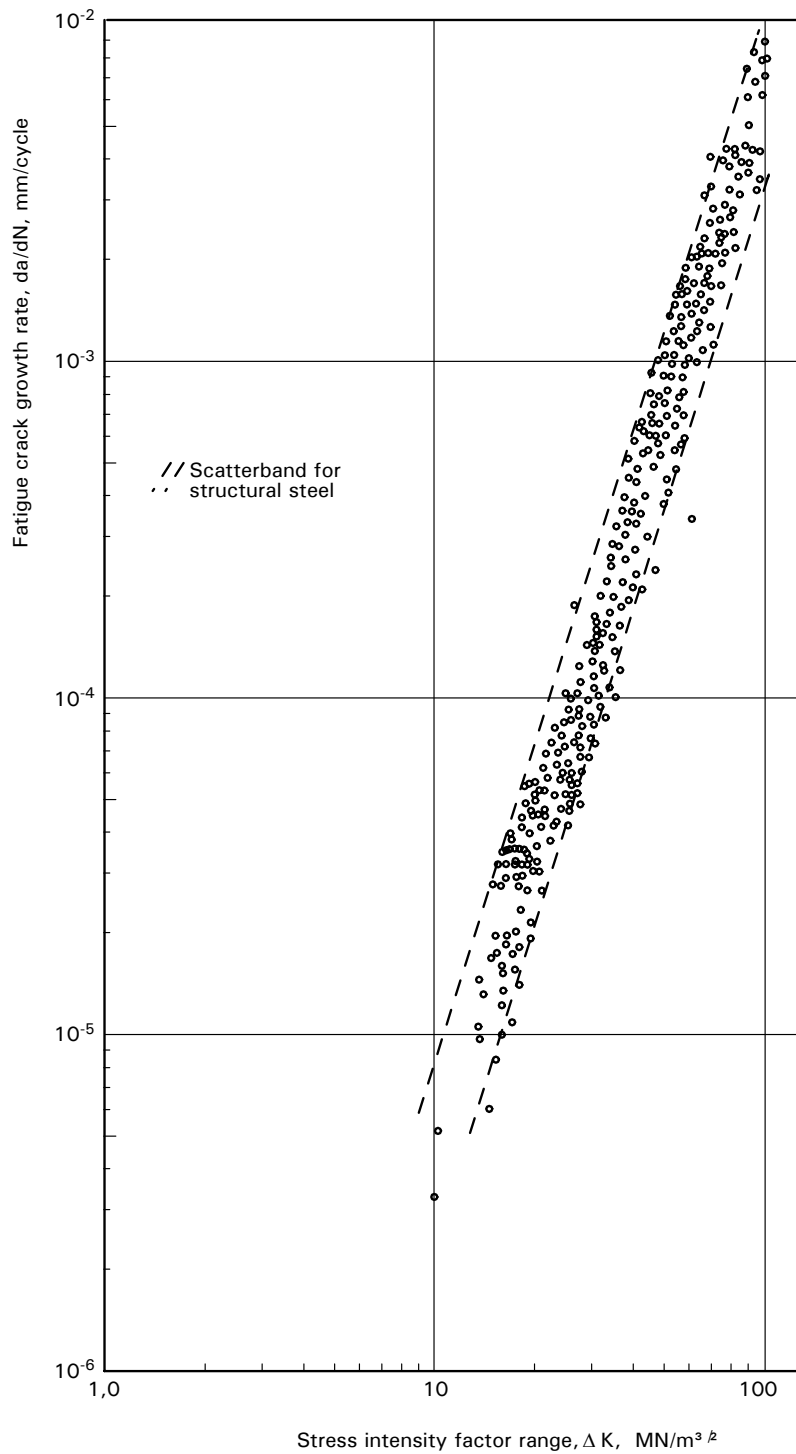

Figure C.8.4 Crack growth rate data for stainless steels in air at temperatures less than 100°C

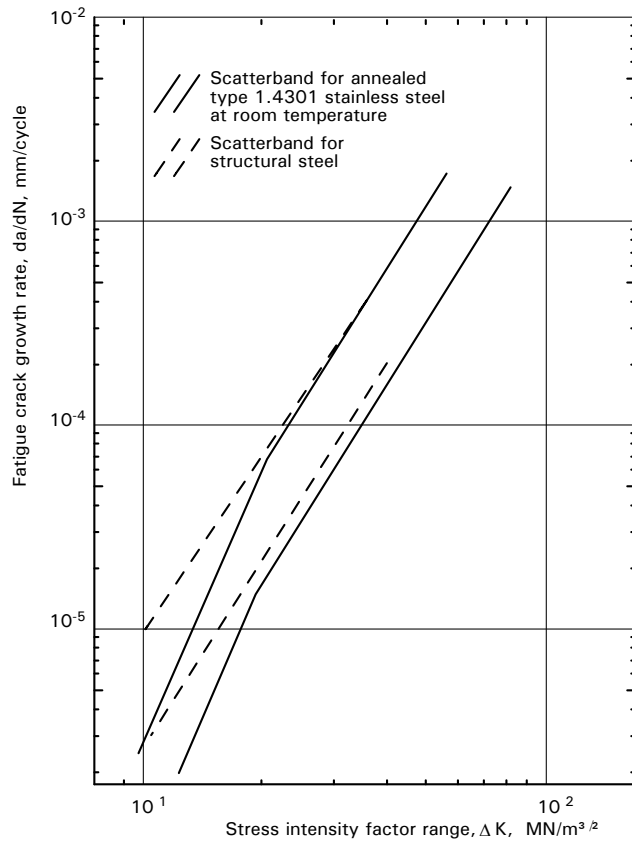

Figure C.8.5 *Fatigue crack growth behaviour of stainless steel grade 1.4301 at room temperature*

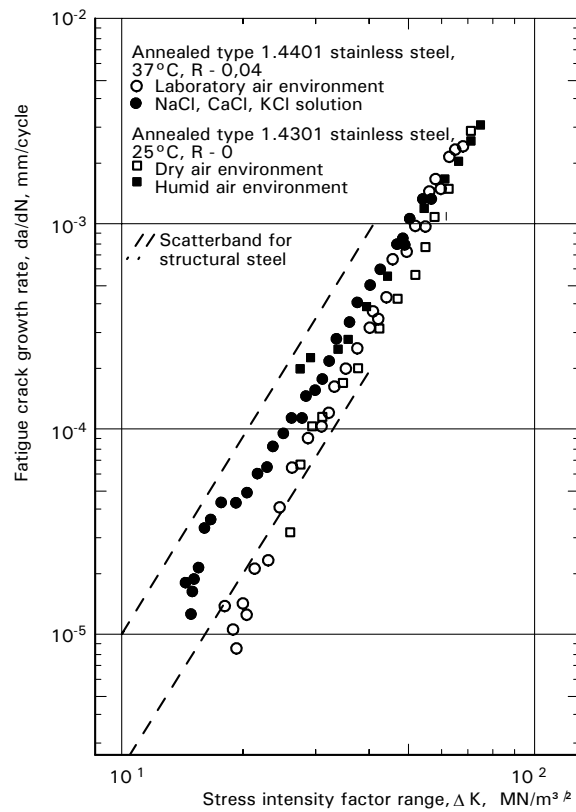

Figure C.8.6 *Comparison of fatigue growth behaviour of austenitic stainless steels*

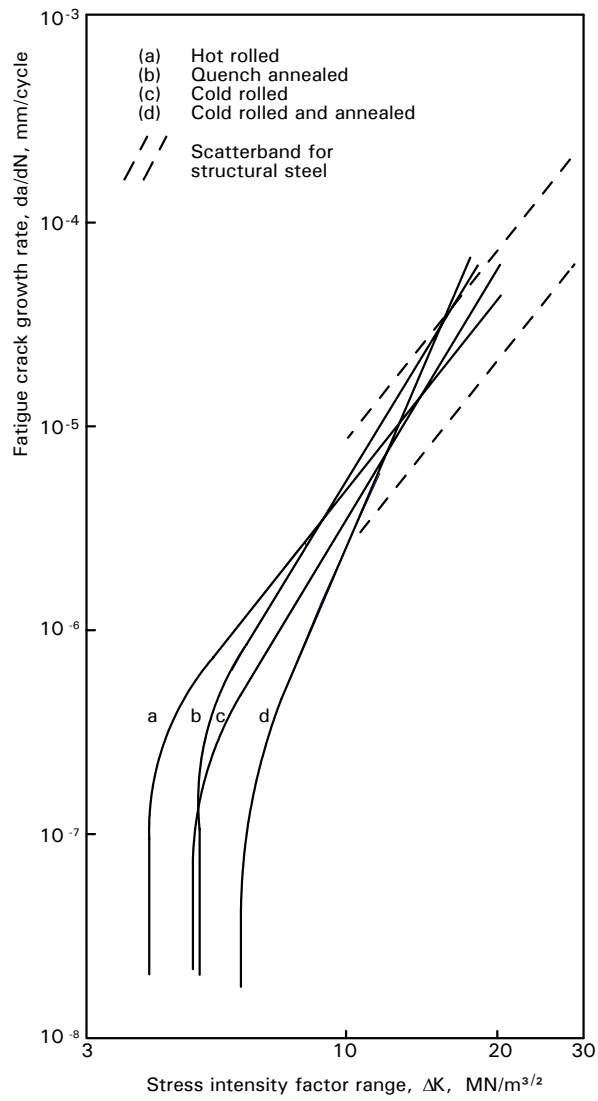

Figure C.8.7 Fatigue crack growth behaviour of duplex grade 1.4462

Table C.8.2 *Fatigue threshold values for stainless steel in air at room temperature*

Material	Yield Strength (N/mm ²)	Stress Ratio <i>R</i>	ΔK_{th} (MN/m ^{3/2})
1.4401 (18Cr, 12Ni)	268	0,08	5,2
		0,1	5,0
		0,2	4,3
		0,38	3,2
		0,5	3,3
1.4401, as previous; aged	292	0,12	3,7
		0,33	3,4
		0,55	2,7
		0,68	2,7
1.4401 (18Cr, 12Ni)	255	0,05	6,8
		0,05	6,1
		0,2	5,3
		0,35	4,5
		0,6	3,0
1.4401 (18Cr, 12Ni)	198	0,02	8,1
		0,2	6,9
		0,33	6,2
		0,35	5,9
		0,61	3,8
1.4301 (18,5Cr, 8,8Ni)	222	0,0	5,5
		0,5	3,1
		0,8	2,9
		0,9	2,3
1.4301 (20,2Cr, 8,5Ni)	265	0,0	3,5
		0,4	3,5
		0,8	4,0
1.4301 (19,2Cr, 10,3Ni)	221	0,0	5,6
		0,17	4,5
		0,37	4,2
		0,80	2,8

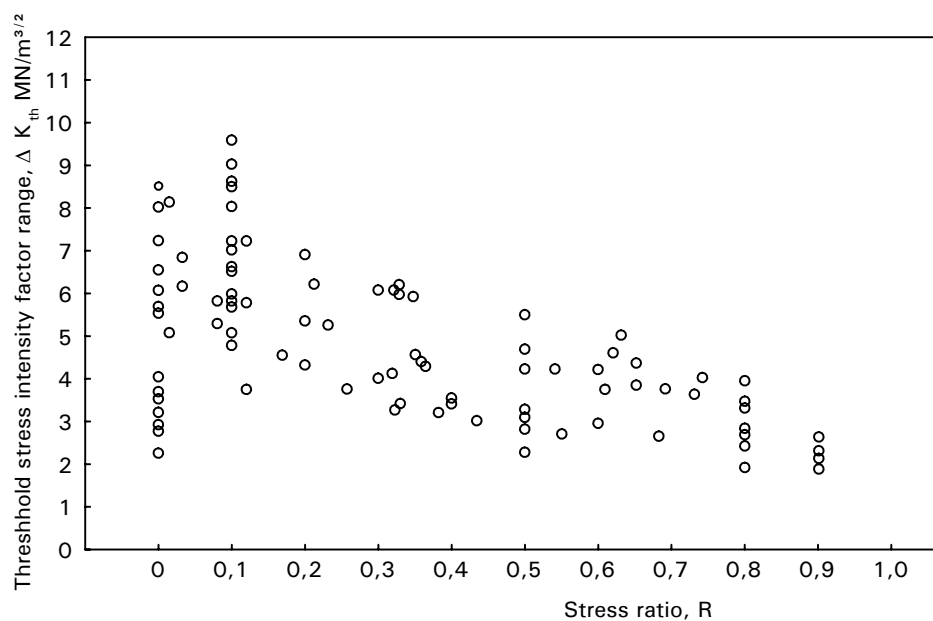

Figure C.8.8 *Variation of threshold stress intensity factor range with stress ratio for stainless steels in air*

C.9 TESTING

The guidance given in the Recommendations has been formulated with the benefit of experience gained in various test programmes that supplied background data for the First Edition of the Design Manual.

It should be appreciated that it is difficult to obtain an accurate stress-strain curve. In particular, it is difficult to obtain a reliable measurement of modulus using extensometry. Other techniques, such as strain gauging or acoustic resonance methods, may prove more satisfactory.

C.10 FABRICATION ASPECTS

C.10.1 Introduction

A broad overview of the precautions to be observed during fabrication is given in the Recommendations and not much further is added in this commentary.

It is emphasised that fabrication should be considered early in the design process as it may affect choice of material grade and structural form (cold formed or welded).

Advice should always be sought if in doubt. Information and literature is freely available from stainless steel producers, weld consumable manufacturers and fabricators. Indeed, much of the information presented in the Recommendations is gathered from such sources. The European specification for fabrication and erection of structural stainless steel, ENV 1090-6¹²⁶, covers materials, storage and handling, forming, cutting, joining methods, tolerances and inspection and testing. Reference 127 gives general information about working with stainless steel.

C.10.2 Storage and handling

The use of appropriate storage and handling procedures will avoid iron contamination and surface damage, both of which may subsequently initiate corrosion. Whereas embedded iron can be relatively easily removed (by pickling), scratches may prove troublesome and costly to rectify on surfaces with fine finishes. Iron contamination is discussed in Reference 128.

Advice on selecting appropriate protective coatings, and their removal, may be found in Reference 129.

C.10.3 Shaping operations

Stainless steel can be machined by all the usual techniques, though different cutting speeds and feeds to those used for carbon steel are normally required. Note that stainless steel swarf is dangerous by virtue of its length and sharpness.

Commonly, brake presses are of 3 m length capacity. However, more powerful machines which cold form longer lengths are available. Discussions with fabricators are recommended to establish plate width and thickness limits.

C.10.4 Welding

The area of stainless steel fabrication where most care is required is welding. That is not to say it is difficult, but rather that corrosion and metallurgical aspects also have to be considered. In general, fabricators who have had experience of working with stainless steels are well informed of the possible pitfalls and their advice should be heeded.

As noted above, steel suppliers and consumable manufacturers produce informative literature. This ranges from brief non-technical pamphlets, through more detailed guidance on recommended joint types and welding parameters, to very technical papers such as the effect of alloying elements on corrosion

resistance in specific environments. There is also a wealth of literature in journals, conference proceedings, etc. However, it is fair to say that most of the literature in journals and conference proceedings has little immediate practical relevance to the structural applications for which this Design Manual has been prepared.

EN 1011-3¹³⁰ contains much useful information about arc welding stainless steels. EN 288-2¹³¹ covers welding procedures and EN 287-1¹³² covers approval testing of welders. Reference 133 gives general information about welding stainless steel. A comparison of the performance of common manual welding processes for stainless steel is given in Reference 134. As well as examining the technical performance, the study considered economic aspects of each process. The report also contains numerous practical comments for welders and welding engineers.

Tuthill¹²⁸ discusses various post weld treatment techniques (mechanical abrasion methods and pickling) to restore the corrosion resistance of the stainless steel. Examples are given of corrosion attacks where simple cleaning procedures were not followed.

Ultrasonics is not normally used for inspecting welds in stainless steel because the grain size in the welds is comparable to the wavelength of the beam which is thus strongly scattered. However, new techniques have been developed¹³⁵ for use in critical applications.

C.10.5 Galling and seizure

References 136 and 137 contain useful information.

C.10.6 Finishing

Reference 138 describes more fully the various options for finishing a fabricated component.

APPENDIX A Correlation between stainless steel designations

Table A.1 is taken from ENV 1993-1-4.

APPENDIX B Lateral-torsional buckling slenderness, λ_{LT}

The various formulae presented in the Recommendations are taken from the June 2002 version of prEN 1993-1-1¹³⁹, which was approved by CEN's sub-committee SC3. These formulae were subsequently removed from the final version of EN 1993-1-1 to allow greater scope of sources of values.

APPENDIX C Material data for deflection calculations

The formula for estimating the secant modulus (using the constants given in Table C.1) is derived from the Ramberg-Osgood description of non-linear stress-strain curves¹³:

$$\varepsilon = \frac{\sigma}{E} + 0,002 \left(\frac{\sigma}{f_y} \right)^n \quad \text{or} \quad \varepsilon = \frac{\sigma}{E} \left[1 + 0,002 \left(\frac{E}{f_y} \right) \left(\frac{\sigma}{f_y} \right)^{n-1} \right]$$

The secant modulus, E_s , is thus

$$E_s = \frac{\sigma}{\varepsilon} = \frac{E}{\left[1 + k(\sigma / f_y)^{n-1} \right]}$$

where $k = 0,002 E/f_y$

The k factors in Table C.1 of the Recommendations are derived from the minimum 0,2% proof strengths given in EN 10088-2 for hot rolled strip/plate and $E=200\,000$ N/mm² as given in EN 10088-1 (Sections 3.1.2 and 3.2.4 of the Recommendations). The secant moduli in Table C.2 of the Recommendations were derived from the given formula and the constants in Table C.1.

The n factors are the exponents of fitted Ramberg-Osgood curves to experimental data¹². It may be noted that a range of n factors can be found depending on how the curve fitting is carried out. For instance, fitting a curve to a number of points on the experimental stress-strain curve up to and beyond the 0,2% proof strength results in relatively high n values. However, forcing the fitted curve to simulate the observed departure from linearity (conventionally taken at the 0,01% proof stress) results in rather lower n values. The latter method was adopted for reasons of conservatism as deflection calculations are carried out at stresses below the 0,2% proof stress (for greater stresses, higher n factors are more conservative).

The constants E , k and n are necessarily derived from short term stress-strain curves and thus do not allow for the effects of room temperature creep. This need only be of concern when there is long term loading at a high level of stress.

REFERENCES

- 1 Boiler and Pressure Vessel Code. Section 3: Rules for Construction of Nuclear Power Plant Components. Division 1: Subsection NF 3000: Component supports.
American Society of Mechanical Engineers, New York, 1983
- 2 ENV 1993-1-1:1992 Eurocode 3. Design of Steel Structures: General rules and rules for buildings
CEN, 1992
- 3 API RP2A – LRFD. Recommended Practice for Planning, Designing and Constructing Fixed Offshore Platforms - Load and Resistance Factor Design
American Petroleum Institute, 1993
- 4 Metals Handbook, 10th Edition. Properties and Selection: Irons, Steels, and High-Performance Alloys
American Society for Metals, Ohio, 1990. Volume 1
- 5 EN 10088: Stainless steels
EN 10088-1:1995: List of stainless steels
EN 10088-2:1995: Technical delivery conditions for sheet/plate and strip for general purposes
EN 10088-3:1995: Technical delivery conditions for semi-finished products, bars, rods and sections for general purposes
CEN, 1995
- 6 EN ISO 3506:1998: Mechanical properties of corrosion-resistant stainless steel fasteners – Specifications
CEN, 1998
- 7 EN 10204:1991: Metallic products. Types of inspection documents.
CEN, 1991
- 8 Technical Report 28: Tests on Stainless Steel Fasteners (SCI-RT230)
The Steel Construction Institute, 1991
- 9 Olsson, A.
WP1: Constitutive model for material behaviour
(ECSC Project – Development of the use of stainless steel in construction, Contract no. 7210 SA/903)
Lulea Institute of Technology, March 2000
- 10 Granlund, J
Structural steel plasticity – Experimental study and theoretical modelling
Doctoral Thesis, Luleå University of Technology, 1997. Thesis 1997:24
- 11 Mechanical and Physical Properties of Austenitic Chromium-Nickel Stainless Steels at Ambient Temperatures (Inco Databook)
Inco Europe Limited, 1963
(Distributed by the Nickel Development Institute)
- 12 Technical Report 30: Results from Test Programme on Materials (SCI-RT251)
The Steel Construction Institute, November 1991

- 13 Ramberg, W. and Osgood, R.
Description of Stress-Strain Curves by Three Parameters (NACA Technical Note 902)
National Advisory Committee for Aeronautics, 1943
- 14 Mirambell, E. and Real, E.
On the calculation of deflections in structural stainless steel beams: an experimental and numerical investigation.
Journal of Constructional Steel Research, Elsevier, 2000. Volume 54, pp 109-133
- 15 Gardner, L.
A new approach to structural stainless steel design
Thesis, University of London, 2002
- 16 Holmes, B. and Gladman, T.
Effect of Nickel and Chromium on the Work Hardening Characteristics of Austenitic Steels
British Steel, May 1970. Publication ref: SF 732,
- 17 Errera, S.J., Popowich, D.W. and Winter, G.
Bolted and Welded Stainless Steel Connections.
Journal of the Structural Division, Proceedings of the American Society of Civil Engineers, 1974. Vol.100, No. ST6. pp 1279-1296
- 18 ENV 1993-1-4: 1996 Eurocode 3: Design of steel structures. General Rules. Supplementary rules for stainless steels
CEN, 1996
- 19 Talja, A.
Test results of RHS, top hat and sheeting profiles
(Building and Transport Internal Report RTE50-IR-28/2002)
Technical Research Centre of Finland (VTT) 2002.
- 20 van den Berg, G.J. and van der Merwe, P.
The prediction of corner mechanical properties for stainless steels due to cold forming
Proceedings of the 11th International Speciality Conference on cold formed steel structures, St Louis, Missouri, USA, 1992
- 21 Dodd, B., Stone, R.C. and Campbell, J.D.
The Strain-Rate Sensitivity of 304L Austenitic Stainless Steel in Uniaxial Tension (Engineering Laboratory Report No. 1069/73)
University of Oxford, August 1973
- 22 Albertini, C. and Montagnani, M.
Wave Propagation Effects in Dynamic Loading.
Nuclear Engineering and Design, 1976. Vol.37, pp 115-124
- 23 Stout, M.G. and Follansbee, P.S.
Strain Rate Sensitivity, Strain Hardening, and Yield Behaviour of 304L Stainless Steel
Transactions of the American Society of Mechanical Engineers, Journal of Engineering Materials and Technology, 1986. Vol.108, pp 344-353
- 24 Marshall, P.
Austenitic Stainless Steels. Microstructure and Mechanical Properties
Elsevier Applied Science Publishers, 1984
- 25 Design guide for stainless steel blast walls
(Fire and Blast Information Group Technical Note 5)
The Steel Construction Institute, 1999

- 26 Krempl, E.
An Experimental Study of Room-Temperature Rate-Sensitivity, Creep and Relaxation of AISI Type 304 Stainless Steel
Journal of the mechanics and physics of solids, 1979. Vol.27 pp 363-375
- 27 ANSI/ASCE - 8 - 90: Specification for the Design of Cold-Formed Stainless Steel Structural Members
American Society of Civil Engineers, 1991
(Superseded by SEI/ASCE 8-02, published in 2002)
- 28 Inco Europe Limited
Austenitic Chromium-Nickel Stainless Steels - Engineering Properties at Elevated Temperatures
Inco Databooks, distributed by the Nickel Development Institute, 1963
- 29 Sanderson, G.P. and Llewellyn, D.T.
Mechanical Properties of Standard Austenitic Stainless Steels in the Temperature range -196° to $+800^{\circ}\text{C}$
Journal of the Iron and Steel Institute, August 1969
- 30 Materials for Cryogenic Service - Engineering Properties of Austenitic Stainless Steels (Inco Databook)
Inco Europe Limited, 1974
(Distributed by the Nickel Development Institute)
- 31 An Architect's Guide on Corrosion Resistance
Nickel Development Institute, 1990
- 32 American Society of Metals Corrosion
Metals Handbook 9th Edition
ASMC, 1987. Volume 13
- 33 Guide to stainless steel finishes
Building Series, Volume 1
Luxembourg, Euro Inox, Second Edition, 2002
- 34 Baddoo, N. R., Burgan, R. and Ogden, R. O.
Architects' guide to stainless steel
Steel Construction Institute, P179, 1995
(Available online at <http://www.steel-stainless.org/architects>)
- 35 Corrosion Tables for Stainless Steels and Titanium
Jernkontoret, Stockholm, Sweden, 1979
- 36 Needham, N.G. et al.
Atmospheric Corrosion Resistance of Stainless Steels
Stainless Steels '87, Proceedings of Conference held at York, September 1987
The Institute of Metals, 1988
- 37 Sheffield Research Laboratories
Stainless Steels Offshore Long Term Corrosion Tests (Technical Note SM/4/81)
British Steel Corporation, August 1981
- 38 PD 6484:1979: Commentary on Corrosion at Bimetallic Contacts and its alleviation
BSI, 1979
- 39 Tuthill, A.H. and Schillmoller, C.M.
Guidelines for Selection of Marine Materials
The International Nickel Company, Inc., 1971

- 40 Stone, P.G., Hudson, R.M. and Johns, D.R.
Performance of Stainless Steels in Topside Construction Offshore
Stainless Steels '84. Proceedings of Conference held at Göteborg, September
1984
The Institute of Metals, 1985
- 41 Money, K.L. and Kirk, W.W.
Stress Corrosion Cracking Behaviour of Wrought Fe-Cr-Ni Alloys in Marine
Atmosphere
Material Performance, 1978. Vol. 17, pp.28-36
- 42 Suzuki, T. et al.
Austenitic-Ferritic Stainless Steels with High-Chromium Low-Nickel Content
Nippon Kinzoku Gakkaishi, 1968. Vol. 32, No. 11, pp. 1171-1177
- 43 Nickel Development Institute
Stainless steel in swimming pool buildings (Pub. No. 12010)
NiDI, 1995
- 44 Stress corrosion cracking of stainless steels in swimming pool buildings
(Sector Information Minute, SIM 5/2002/18, Version 1: 02/08/2002)
Health and Safety Executive, Field Operations Directorate, Food and
Entertainment Sector, 2002
The Stationery Office, 2002
- 45 BS 5950-1:2000 Structural Use of Steelwork in Building. Code of practice for
design – rolled and welded sections
BSI, 2001
- 46 BS 5950-5:1998 Structural Use of Steelwork in Building. Code of practice for
design of cold formed thin gauge sections
BSI, 1998
- 47 Development of the use of stainless steel in construction
Final report, Directorate-General for Research,
European Commission, Technical Steel Research EUR 20030 EN, 2001
- 48 ENV 1993-1-3: 1996 Eurocode 3. Design of Steel Structures. General rules.
Supplementary rules for cold formed thin gauge members and sheeting
CEN, 1996
- 49 ENV 1993-1-2: 1995 Eurocode 3: Design of steel structures. Structural fire
design
CEN, 1995
- 50 ENV 1993-1-5:1997: Eurocode 3: Design of steel structures. General rules.
Supplementary rules for plated planar structures without transverse loading
CEN, 1997
- 51 BS 8118:1991 Code of Practice for the Design of Aluminium Structures
BSI, 1991
- 52 Dier, A. F.
Comparison of Steel and Aluminium Plate Strengths
Proceedings of International Conference on Steel and Aluminium Structures,
Cardiff, UK, 8-10 July 1987
- 53 Little, G. H.
Collapse Behaviour of Aluminium Plates
International journal of mechanical science, 1982. Vol. 24, No. 1, pp. 37-45

- 54 Moffin, D. S. and Dwight, J. B.
Buckling of Aluminium Plates in Compression
In: Rhodes and Spence (eds): Behaviour of Thin-Walled Structures
Elsevier Applied Science Publishers, 1984
- 55 Winter, G.
Thin-Walled Structures, Theoretical Solutions and Test Results
In: Proc. IABSE Eighth Congress, 9 -14 September, 1968
International Association for Bridge and Structural Engineering, 1968
- 56 prEN 1993-1-5: Eurocode 3: Design of steel structures. Plated structural elements
CEN TC/250/SC3 committee document, November 2001
- 57 Dier, A. F.
Collapse of Metal Plates
Ph.D. Thesis, University of London, 1981
- 58 Anderson, R. A. and Anderson, M. S.
Correlation of Crippling Strength of Plate Structures with Material Properties
(NACA Technical Note 3600)
National Advisory Committee of Aeronautics, 1956
- 59 Johnson, A. L. and Winter, G.
Behaviour of Stainless Steel Columns and Beams
Journal of the Structural Division, Proceedings of the American Society of Civil Engineers
ASCE, October 1966
- 60 Wang, S. T. and Winter, G.
Cold rolled Austenitic Stainless Steel: Material Properties and Structural Performance (Report No 334)
Department of Structural Engineering, Cornell University, July 1969.
- 61 Johnson, A. L. and Winter, G.
The Structural Performance of Austenitic Stainless Steel Members (Report No. 327)
Department of Structural Engineering, School of Civil Engineering, Cornell University, 1966
- 62 Yamada, S. et al.
Ultimate Strength of H-shaped Stub-columns of Stainless Steel
Proceedings Institute of Architects, Japan, October 1988
- 63 Technical Report 22 - Local Buckling of Stainless Steel Elements (SCI-RT158)
The Steel Construction Institute, September 1990
- 64 Dowling, P. J. and Burgan, B. A.
Shear Lag in Steel and Composite Structures: A State of the Art Review.
Proceedings of International Conference on Steel and Aluminium Structures, Cardiff, UK, 8-10 July 1987
- 65 Harding, J. E., Hobbs, R. E., Neal, B. G. and Slatford, J. E.
Parametric Study on Plates under Combined Direct and Shear In-Plane Loading (Engineering Structures Laboratories Report No. BG 44).
Civil Engineering Department, Imperial College, October 1976

- 66 Burgan, B. A. and Dowling, P. J.
Effect of Shear lag on the Collapse of Stiffened Compression Flanges.
ECCS Colloquium on Stability of Plate and Shell Structures, Ghent University,
6-8 April 1987
- 67 BS 5400-3:2000 Steel, Concrete and Composite Bridges. Code of practice for
Design of Steel Bridges
BSI, 2001
- 68 Moffat, K. R. and Dowling, P. J.
Shear Lag in Steel Box Girder Bridges
The Structural Engineer, 1975. Vol. 53, No. 10, pp. 439-448
The Institution of Structural Engineers, 1975
- 69 Yu, W-W.
Cold-Formed Steel Design
John Wiley & Sons, New York, 1985
- 70 prEN 1993-1-3: Eurocode 3: Design of steel structures. General rules.
Supplementary rules for cold formed thin gauge members and sheeting
CEN TC/250/SC3 committee document, September 2002
- 71 Talja, A.
Test report on welded I and CHS beams, columns and beam-columns (Report to
the ECSC)
Technical Research Centre of Finland (VTT), Finland, December 1997.
- 72 Talja, A
Design of stainless steel members and sheetings
(Internal project summary report No RTE38-IR-6/2000)
Technical Research Centre of Finland (VTT), Finland, 2000
- 73 Cold-Formed Steel Design Manual
American Iron and Steel Institute, 1986
- 74 Young, W. C. and Budynas. R. G.
Roark's Formulas for Stress and Strain (7th edition)
McGraw-Hill International Book Company, 1976
- 75 Technical Report 26: Results from Net Section Tests (SCI-RT179)
The Steel Construction Institute, July 1991
- 76 Eurocode 3 Part 1
Background Documentation - Chapter 5, Document 5.04
Prepared for the Commission of the European Communities by the Eurocode 3
Editorial Group
CEN TC/250/SC3 committee document
- 77 Technical Report 29: Tests on Stainless Steel Beams and Columns (SCI-RT231)
The Steel Construction Institute, July 1991
- 78 Hammer, E. W. Jr. and Petersen, R. E.
Column Curves for Type 301 Stainless Steel
Aeronautical Engineering Review, 19955. Vol. 14, Part 12, pp 33-39, 45, 48
- 79 Johnson, A. L. and Winter, G.
Behaviour of Stainless Steel Columns and Beams
Journal of the Structural Division
Proceedings of the American Society of Civil Engineers, October 1966

- 80 Johnson, A. L. and Winter, G.
The Structural Performance of Austenitic Stainless Steel Members (Report No. 327)
Department of Structural Engineering, School of Civil Engineering, Cornell University, November 1966
- 81 Coetzee, J. S., van den Berg, G. J., and van der Merwe, P.
The Behaviour of Stainless Steel Lipped Channel Axially Loaded Compression Members
Faculty of Engineering, Rand Afrikaans University, March 1990. Report MD-55
- 82 Rasmussen, K. J. R. and Hancock, G. J.
Stainless Steel Tubular Columns - Tests and Design
Tenth International Speciality Conference on Cold-Formed Steel Structures, St. Louis, Missouri, USA, October 1990
- 83 Way, J
WP3.1, 3.2, 3.3: Beams, columns and beam-columns – CHS
(ECSC Project – Development of the use of stainless steel in construction, Contract number 7210SA/842)
SCI, March, 2000
- 84 van den Berg, G. J., van der Merwe, P. and Bredekamp, P. J.
The Strength of Type 3CR12 Corrosion Resisting Steel Built-up I-Section Column and Beams
Faculty of Engineering, Rand Afrikaans University, March 1990. Report MD-51
- 85 Stangenberg, H.
WP3.1, 3.1 & 3.3 Beams, columns and beam-columns – welded I-sections
(ECSC Project – Development of the use of stainless steel in construction, Contract number 7210SA/134)
RWTH, March 2000
- 86 van den Berg, G. J.
The Torsional Flexural Buckling Strength of Cold-Formed Stainless Steel Columns
Ph.D Thesis, Faculty of Engineering, Rand Afrikaans University, 1988
- 87 van den Berg, G. J. and van der Merwe, P.
The Torsional Flexural Buckling Strength of Cold-Formed Stainless Steel Columns
Faculty of Engineering, Rand Afrikaans University, June 1988. Report MD-47
- 88 van Wyk, M. L., van den Berg, G. J. and van der Merwe, P.
The Lateral Torsional Buckling Strength of Doubly Symmetric Stainless Steel Beams
Faculty of Engineering, Rand Afrikaans University, May 1990. Report MD-58
- 89 Strength and Deformation of H-shaped Stainless Steel Beams
Journal of the Kanto Branch, Japanese Institution of Architecture, 1988
(In Japanese.)
- 90 Carvalho, E. C. G., van den Berg, G. J. and van der Merwe, P.
Local Shear Buckling in Cold-Formed Stainless Steel Beam Webs
Proceedings of the Annual Technical Session, Structural Stability Research Council, April 1990
- 91 Olsson, A.
Stainless steel plasticity – Material modelling and structural applications
Doctoral Thesis, Luleå University of Technology, 2001. Thesis 2001:19

- 92 Real, E.
Aportaciones al estudio del comportamiento en flexión de estructuras de acero inoxidable.
Tesis Doctoral, Departamento de Ingeniería de la Construcción, UPC-ETSECCP. Barcelona, May 2001.
- 93 Selen, E.
WP3.5: Web crippling
(ECSC Project – Development of the use of stainless steel in construction
Contract no. 7210 SA/903)
Lulea Institute of Technology, March 2000
- 94 Timoshenko, S.
Strength of Materials. Part II Advanced Theory and Problems (3rd Edition)
Van Nostrand Reinhold Company, New York, 1956. pp 366-374
- 95 Baddoo, N.R. and Burgan, B.A.
Structural design of stainless steel (SCI-P291)
The Steel Construction Institute, 2001
- 96 Owens, G. W. and Cheal, B. D.
Structural Steelwork Connections
Butterworth & Company Limited, 1989
- 97 Technical Report 21: Interim Results from Test Programme on Connections
(SCI-RT157)
The Steel Construction Institute, September 1990
- 98 Errera, S. J., Tang, B. M. and Popowich, D. W.
Strength of Bolted and Welded Connections in Stainless Steel
Dept. Structural Engineering, Cornell University, August 1970. Report No. 335
- 99 van der Merwe, P.
Development of Design Criteria for Ferritic Stainless Steel Cold-Formed
Structural Members and Connections
PhD Thesis, University of Missouri-Rolla, 1987
- 100 Ryan, I.
WP4.2: Bolted connections
(ECSC Project – Development of the use of stainless steel in construction,
Contract number 7210SA/327)
CTICM, March, 2000
- 101 Stangenberg, H.
WP4.1: Welded connections
(ECSC Project – Development of the use of stainless steel in construction,
Contract number 7210SA/134)
RWTH, March, 2000
- 102 EN 10002-1: 2001 Tensile testing of metallic materials. Method of test at
ambient temperature
CEN, 2001
- 103 Kruppa, J, Newman, G, Schleich, J-B and Twilt, L
ECCS Model code on fire engineering
(Unpublished final draft, 1999)
- 104 prEN 1993-1-2 Eurocode 3: Design of steel structures. General rules - Structural
fire design
CEN TC/250/SC3 committee document, February 2002

- 105 ENV 1991-2-2: 1996 Eurocode 1: Basis of design and actions on structures. Actions on structures exposed to fire
CEN, 1996
- 106 Zhao, B.
WP5.1: Material behaviour at elevated temperatures
(ECSC Project – Development of the use of stainless steel in construction, Contract number 7210SA/327)
CTICM, March 2000
- 107 Ala-Outinen, T.
Fire resistance of austenitic stainless steels Polarit 725 (EN 1.4301) and Polarit 761 (EN 1.4571) (Research Notes 1760)
Technical Research Centre of Finland (VTT), Finland 1996
- 108 Baddoo, N. R. and Gardner, L.
WP5.2: Member behaviour at elevated temperatures
(ECSC Project – Development of the use of stainless steel in construction, Contract no. 7210 SA/842)
The Steel Construction Institute, March 2000
- 109 Ala-Outinen, T and Oksanen, T.
Stainless steel compression members exposed to fire (Research Notes 1864)
Technical Research Centre of Finland (VTT), Finland 1997
- 110 Gurney, T. R.
Fatigue of welded structures (2nd edition)
Cambridge University Press, 1978
- 111 Koskimäki M. and Kyröläinen, A.
The fatigue endurance of stainless steels
In: Kähönen A, Sipilä S. (eds) Väsymismitoitus (Fatigue design), VTT Symposium 137, Espoo, Finland, 1993
Technical Research Centre of Finland (VTT), 1993. pp 217-38
- 112 Koskimäki M. and Niemi E.
Fatigue strength of welded joints in three types of stainless Steel Construction Institute
International Institute of Welding, 1995. IIW Document No XIII-1603-95
- 113 Razmjoo, G.
Design guidance on fatigue of welded stainless steel joints
Proceedings of Offshore Mechanical and Arctic Engineering Conference (OMAE '95), Vol 3, Materials Engineering
ASME 1995. pp 163-171
- 114 Lihavainen, V., Niemi, E. and Viherma, R.
WP7: Fatigue
(ECSC Project – Development of the use of stainless steel in construction, Contract no 7210 SA/904)
Outokumpu, March 2000
- 115 prEN 1993-1-9 Eurocode 3: Design of steel structures. Fatigue
CEN TC/250/SC3 committee document, August 2002
- 116 Koskimäki M.,
Ruostumattomien terästen hitsausliitosten väsymisominaisuudet,
Thesis for the degree of Licentiate of Technology, Lappeenranta University of Technology, Department of Mechanical Engineering, Lappeenranta 1995
(in Finnish)

- 117 Maddox S. J.,
Developments in fatigue design codes and fitness-for-service assessment methods,
Proceedings of the International Conference on Performance of Dynamically
loaded Welded Structures, San Francisco, July 1997 (IIW 50th Annual Assembly
Conference)
- 118 Marquis G.B.,
High cycle spectrum fatigue of welded components,
Thesis for the degree of Doctor of Technology, published as VTT
publication 240
Technical Research Centre of Finland (VTT), Espoo 1995
- 119 James, E.A. and Jubb J.E.M.,
The fatigue strength of fillet welded joints in 18-8 type austenitic steels, ambient
and low temperatures
Australian Welding Journal, 1972. Vol 10, No 7, pp 19-21
- 120 Mathers, E. and Jubb, J.E.M.,
The fatigue of stainless steel fillet welds at low temperatures
Proc Conference Welding low temperature containment plant
The Welding Institute, 1973. pp 130-139
- 121 Gurney, T. R. and Maddox, S. J.
A re-analysis of fatigue data for welded joints in steel
Welding Research International, Vol 3, No 4, 1973. pp 1-54
- 122 Maddox, S.J.
Fatigue crack propagation data obtained from parent plate weld metal and HAZ
in structural steels
Welding Research International, 1974. 4 36
- 123 James, L.A.
Fatigue crack propagation in austenitic stainless steel
Atomic Energy Review, 1976. 14 (1) pp 37-86
- 124 Wasén, J., Karlsson, B. and Nyström, M.
Fatigue crack growth properties of SAF 1.4462
Nordic Symposium on Mechanical Properties of Stainless Steels, Sigtuna,
Sweden, October 1990
- 125 Taylor, D.
A compendium of fatigue thresholds and crack growth
EMAS
- 126 ENV 1090-6:2001 Execution of steel structures. Supplementary rules for stainless
steel
CEN, 2001
- 127 Working with stainless steel
Material and Applications Series, Volume 2
La Société d'Ingénierie, de Recherche, de Prospective et d' Edition, Paris
Euro Inox, 1998
- 128 Tuthill, A.H.
Fabrication and Post-Fabrication Cleanup of Stainless Steels
Chemical Engineering, 1986. Vol.93, No.18
(Also available from the Nickel Development Institute, NiDI Technical Series
No. 10004.)

- 129 Stott, D.M.
Protection Masks for Metal Surfaces - Application, Selection and Removal
Stainless Steel Industry, May 1979
- 130 EN 1011-3:2000 Welding. Recommendations for welding of metallic materials. :
Arc welding of stainless steels
CEN, 2000
- 131 EN 288-2:1992 Specification and approval of welding procedures for metallic
materials. Welding procedure specification for arc welding
CEN, 1992
- 132 EN 287-1:1992 Approval testing of welders. Fusion welding, Steels
CEN, 1992
- 133 Welding of stainless steel
Material and Applications Series, Volume 3
Luxembourg, Euro Inox, Second Edition, 2002
- 134 McClintock, A., Scholz, W. and Hayward, P.
Comparison of Stainless Steel Welding Processes (HERA Report R8-03.)
New Zealand Heavy Engineering Research Association, Auckland, New Zealand
- 135 Stringfellow, M. and Hawker, B.
New Ultrasonic Scanner for Inspection of Austenitic Steel
Joining and Materials, October 1988. pp 170-173
- 136 White, P.E. and Hemingway, R.D.
Mechanical Joints in Stainless Steel
Stainless Steels, Iron and Steel Institute publication 117, 1969, pp 85-93
- 137 White, P.E.
Coating of Bolts to Prevent Seizure
Chemistry and Industry, August 1964. pp 1468-90
- 138 Lehnen, K.W.
Mechanical Finishing of Stainless Steel Fabrications
Metal Construction, June 1987, pp 319-323
- 139 prEN 1993-1-1 Eurocode 3: Design of steel structures. General rules and rules
for buildings
CEN TC/250/SC3 committee document, 2002